



GrowSpan™ Estate Pro I Greenhouse



Photo may show a different but similar model.

©2016 GrowSpan
All Rights Reserved. Reproduction
is prohibited without permission.



WARNING: Cancer and Reproductive Toxicity - P65Warnings.ca.gov

STK#	DIMENSIONS
104564	11'-8" W x 8'-10" H x 16'-6" L
103967	11'-8" W x 8'-10" H x 24'-8" L

Revision date: 01.01.16



YOU MUST READ THIS DOCUMENT BEFORE YOU BEGIN TO ASSEMBLE THE SHELTER.

Thank you for purchasing this Growspan™ greenhouse. When properly assembled and maintained, this product will provide years of reliable service. These instructions include helpful hints and important information needed to safely assemble and properly maintain the greenhouse. Please read these instructions **before** you begin.

SAFETY PRECAUTIONS

- Wear eye protection and gloves when handling panels and frame parts.
- Frame is metal. Use a portable GFCI when working with power tools and cords.
- Do not climb on the greenhouse or framing during or after construction.
- Do not occupy the greenhouse during high winds, tornadoes, or hurricanes.
- Provide adequate ventilation if the structure is enclosed.
- Do not store hazardous materials in the greenhouse.
- Provide proper ingress and egress to prevent entrapment.

ANCHORING INSTRUCTIONS

Prior to assembling this greenhouse, please read the **MUST READ** document included with the shipment.

⚠ WARNING: The anchor assembly is an integral part of the greenhouse construction. Improper anchoring may cause greenhouse instability and failure of the structure. Failing to anchor the greenhouse properly *will void the manufacturer's warranty* and may cause serious injury and damage.

IMPORTANT! INVENTORY THE PARTS

1. Open one box and use the Bill of Material included in that box to take an inventory of the contents.
2. Return all parts and the Bill of Material to the box and repeat the procedure for all remaining boxes.
3. Call Customer Service at 1.800.245.9881 to report any missing parts before you begin assembling the greenhouse.

LOCATION

Choosing the proper location is an important step before you begin to assemble the structure.

The following suggestions and precautions will help you determine whether your selected location is the best location.

- Never erect the structure under power lines.
- Identify whether underground cables and pipes are present *before* preparing the site or anchoring the structure.
- Location should be away from structures that could cause snow to drift on or around the building.
- Do not position the greenhouse where large loads such as snow and ice, large tree branches, or other overhead obstacles could fall.
- *Always check local building codes before you begin.*

SITE

After choosing a location, proper preparation of the site is essential. The following site characteristics will help ensure the integrity of the structure.

- *A level site is required.* The site must be level to properly and safely erect and anchor the structure.
- **Drainage:** Water draining off the structure and from areas surrounding the site should drain away from the site to prevent damage to the site, the structure, and contents of the structure.

⚠ WARNING: The individuals assembling this structure are responsible for designing and furnishing all temporary bracing, shoring and support needed during the assembly process.

For safety reasons, those who are not familiar with recognized construction methods and techniques *must seek the help of a qualified contractor.*

ASSEMBLY NOTE

The assembly of this greenhouse is not complex; however, it does take time and additional assistance. *For best results, read through these instructions before you begin to get an overview of the entire assembly.* Then, follow these instructions as presented.

Examine all diagrams and photos and verify that you have selected the proper parts from the correct box or boxes. Do not mix parts from different boxes. When checking parts, place the parts back into the same box they were removed from and continue with the next box.

ASSEMBLY PROCEDURE

Following the instructions as presented will help ensure the proper assembly of your greenhouse. Failing to follow these steps may result in an improperly assembled and anchored greenhouse and may void all warranty and protection the owner is entitled.

The steps outlining the assembly process are as follows:

1. Verify that all parts are included in the shipment. Notify Customer Service for questions or concerns.
2. Read these instructions and all additional documentation included with the shipment *before* you begin assembling the greenhouse.

Use these instructions and the Bill of Material (inside each box) when assembling the greenhouse.
3. Gather the tools, bracing, ladders (and lifts if applicable), and assistance needed to assemble the greenhouse.
4. Re-evaluate the location and site based on the information and precautions presented in the documentation included with the shipment.
5. Lay out the site (if this has not been completed).
6. Assemble the base frame (additional purchase required) and greenhouse components in the order they are presented in these instructions.
7. Anchor the greenhouse as instructed.
8. Read the greenhouse care and maintenance information at the end of these instructions.
9. Complete and return all warranty information as instructed.

REQUIRED TOOLS

The following list identifies the main tools needed to assemble the shelter. Additional tools and supports may be needed depending on the structure, location, and application.

- Tape measure or measuring device
- Metric and standard wrench set (or ratchet and socket set)
- Phillips screwdriver
- Needle-nose pliers
- Ladders and/or work platforms
- Caulk gun for silicone application
- Utility knife

GREENHOUSE PARTS

All greenhouse sections (e.g., roof, sides, end walls, etc.) are shipped in individually numbered boxes. The quantity of boxes may differ depending on the greenhouse.

To prevent mixing the parts while assembling the greenhouse, select the boxes as instructed and open that box only and assemble its contents.

OPEN BOXES AS INSTRUCTED TO PREVENT MIXING OF THE CONTENTS.

NOTE: Some photos and diagrams throughout these instructions may show a greenhouse with slightly different dimensions, color, or design. The assembly procedures are identical regardless of these differences. Notable differences are addressed.

For a quick overview of this greenhouse, consult the diagrams in the Quick Start section near the back of these instructions.

Those not familiar with the assembly of similar structures and the use of common hand tools *must seek the assistance* of someone with such experience.

⚠ WARNING: Do not allow the polycarbonate panels to remain in direct sunlight until they are installed. Doing so will cause the protective film to become difficult if not impossible to remove.

*Consult page 39 for additional polycarbonate and how to use vent tape (additional purchase required) information **before** installing any polycarbonate panel.*

PART IDENTIFICATION NUMBERS

All main parts include a stamped ID number. Use this number when selecting the required parts during the assembly.

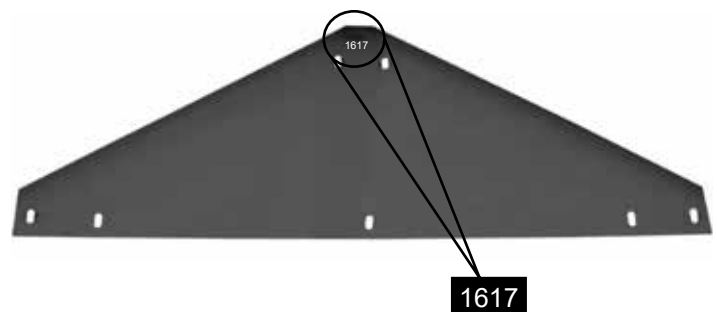

NOTE: The locations of the part numbers on the components may vary. Refer to the Bill of Materials shipped within each box for a description of each part.



Estate Pro I Greenhouses

EXTRA PARTS PROVIDED FOR GREENHOUSE

ATTENTION: TO AVOID TWISTING OFF OR DAMAGING THE FASTENERS, DO NOT OVERTIGHTEN.

FOR YOUR CONVENIENCE, ADDITIONAL FASTENERS AND PLASTIC MOLDING CAN BE FOUND IN THE "EXTRA PARTS" BAG OR BOX.

REFER TO THE BILL OF MATERIALS FOR A LIST OF THE FASTENERS AND MOLDING CONTAINED IN THAT BAG OR BOX.

The plastic profile can be trimmed to the required length if a piece is misplaced or damaged during installation.

IMPORTANT: Consult the "extra parts" for items you need before contacting customer service to request a replacement for damaged or missing parts or fasteners.

OVERVIEW

This section is an overview of the process for assembling your Estate Pro I Greenhouse. See illustration below to identify main parts of greenhouse.

1. Locate the required parts for each assembly procedure.
2. Preassemble the base frame (additional purchase required), end walls, and side walls as instructed.
3. Assemble the frame and install the ridge beam, rafters, and vents.
4. Square and anchor the greenhouse.
5. Assemble and attach the doors.
6. Attach gutter rail ends.
7. Install the polycarbonate panels.
8. Attach door stops and downspouts.

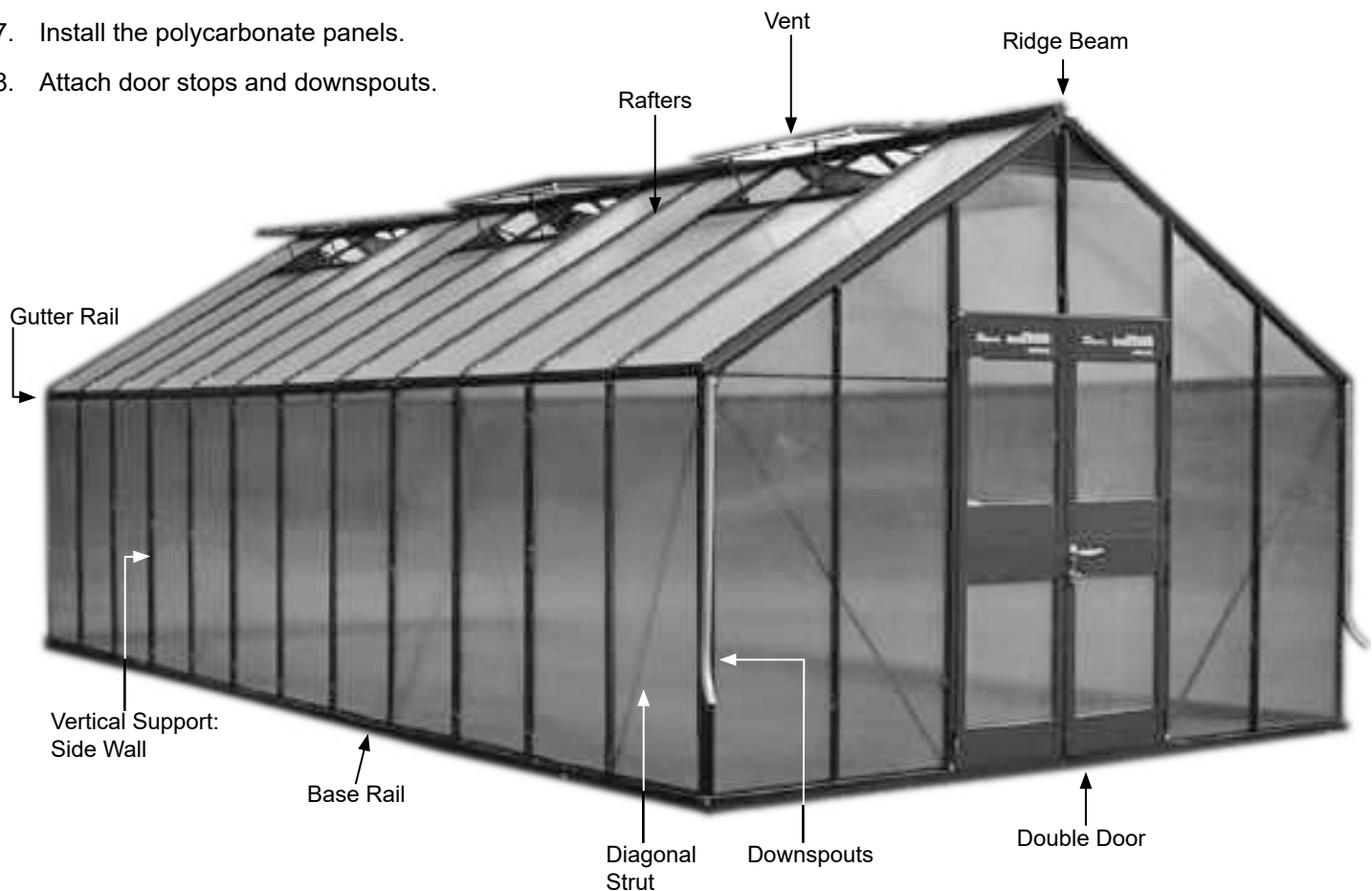

BASE FRAME ASSEMBLY (OPTIONAL PURCHASE)

The base frame assembly provides a level, square surface on which to set the greenhouse frame. *It is strongly recommended that you use this base.*

The optional base (additional purchase required) is assembled and squared, its posts set into the ground. It is then anchored in place using ground posts or other approved anchoring methods described in these instructions.

This base is an optional purchase. Contact your sales consultant at 1-800-245-9881 to purchase the base.

The following steps describe how to assemble the optional base frame for the greenhouse.

1. Unpack the base kit to identify the parts.

NOTE: The base is assembled upside down and then is flipped when it is positioned on the site.

2. Identify the base channel lengths used for the ends (width) and the sides (length).
3. Select the first frame support post and the required nuts and bolts and place these at one corner of the base.

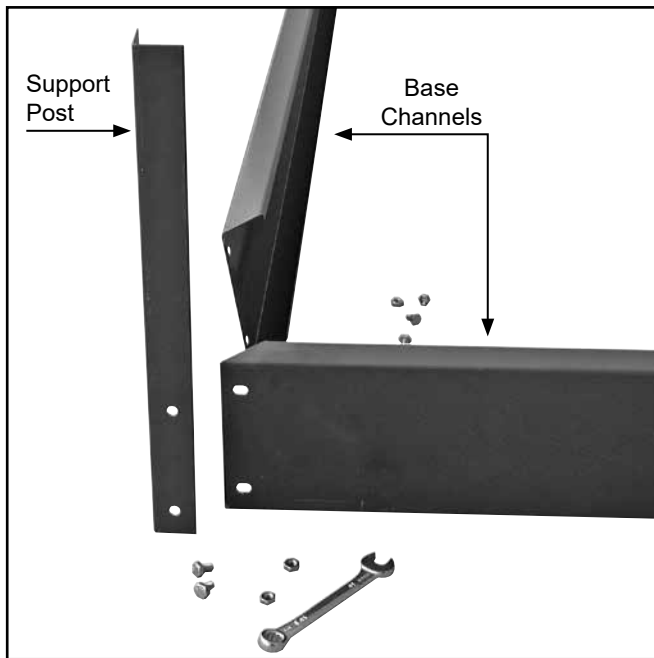

ATTENTION: If you plan to place the base on a concrete slab or patio, you must remove the "leg" portion of the frame support posts. Before you assemble the base as shown below, cut the frame support posts so they are the same length as the base channel is wide.

Cut these only if you plan to place the frame, and ultimately the greenhouse, on a concrete slab.

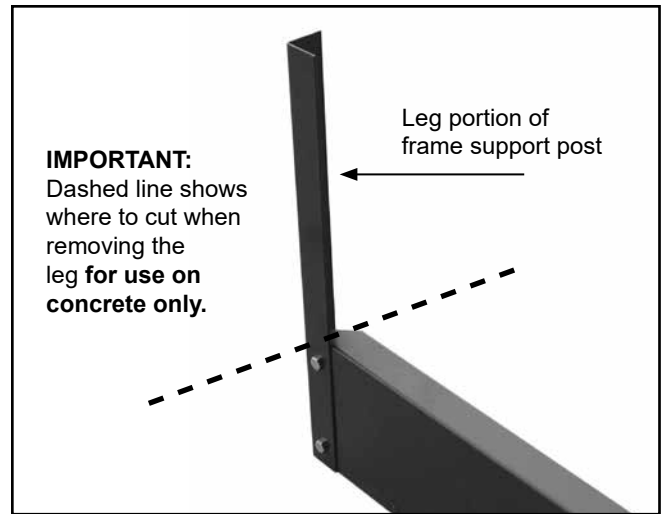

4. Insert two bolts through the pre-drilled holes in the post and one base channel and add the nuts.

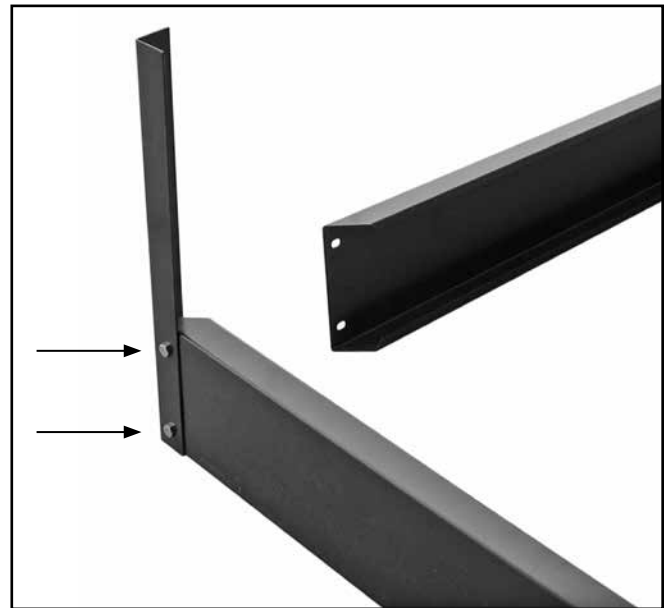

NOTE: Do not tighten the bolts at this time.

5. Select the remaining bolts and repeat the previous step to attach the remaining base channel to the support post.

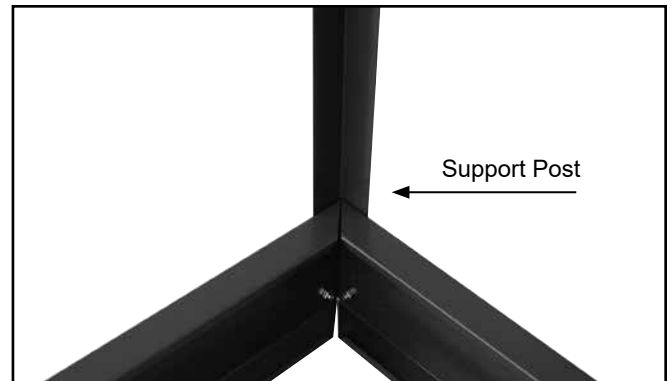

GROWSPAN™ ESTATE PRO I GREENHOUSES

BASE FRAME ASSEMBLY (CONTINUED)

6. Verify that the post is straight and tighten the bolts
7. Repeat the procedure to attach the remaining support posts to the base channels.

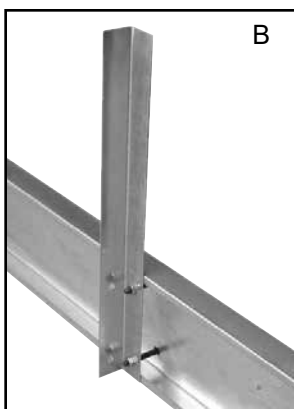
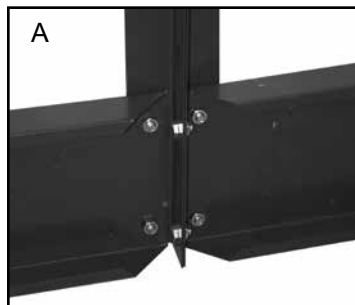
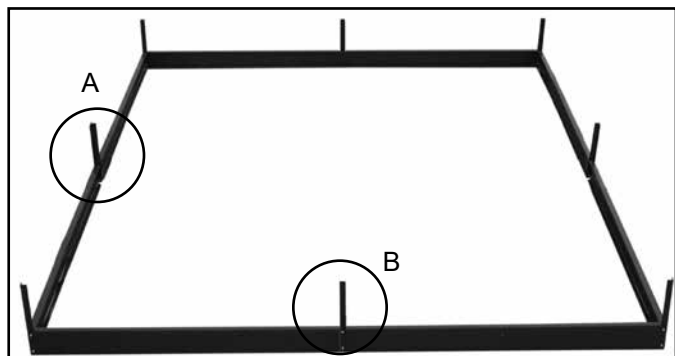

8. After the frame is assembled and all bolts are tight, flip the base over and set it on the site.

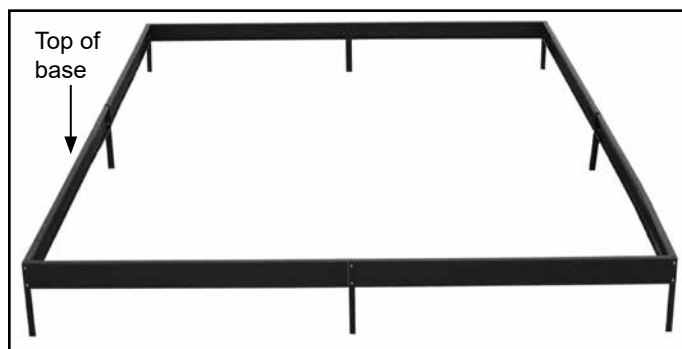

9. Continue with the next procedure.

NOTE: If additional legs are present, use the longer bolts included with the kit to secure the legs to the frame.

PACKING LIST NOTE (OPTIONAL BASE FRAME ONLY)

Some packing lists included with the optional base kit may show J-clips as an included item. These J-clips are no longer used and are not included in the shipped items.

The self-tapping screws are now included and are used instead. Consult the anchoring instructions within this document for additional information.

SQUARE THE BASE

Before the support posts of the base are driven into the ground and before the assembled greenhouse frame is set on and secured to the base, you must square the base assembly and anchor the base to the site.

ATTENTION: If you are setting the base and greenhouse on a patio or concrete slab, set the assembled base on site and continue with the greenhouse assembly procedures that follow. *Do not square the base at this time.*

This base and greenhouse require a level site. Before setting the base or greenhouse frame (or both) in place, you must *level the site*.

The easiest way to square the base is to measure diagonally from corner to corner.

Complete these steps:

NOTE: The following procedure describes how to square the base on a prepared site and drive the base support posts into the ground.

1. Position the assembled base on the site as shown below.
2. Measure diagonally from corner-to-corner.

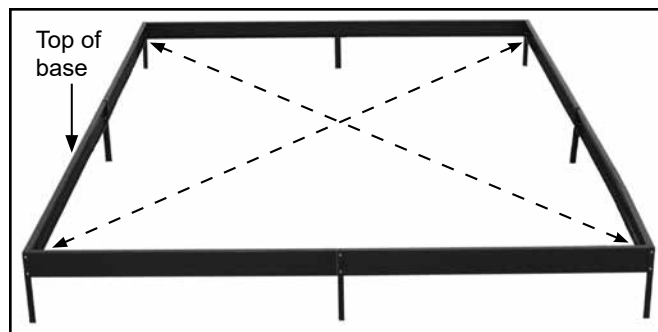

NOTE: The frame is square when both measurements are the same.

3. When the frame is square, tap the support posts into the ground to set the frame in place and recheck the measurements.

NOTE: Place a block of wood on top of the base channel and support post and hammer on the wood to protect the frame when driving the posts into place.

4. Continue to drive the posts to the desired depth.

NOTE: Use a level (or string a line) to verify that the base remains level when set into the ground

5. After setting the base on the site, continue with the greenhouse assembly.

ASSEMBLE THE END WALL FRAMES

The greenhouse has two end walls: one is the door end and one is the non-door end.

Greenhouse Sku Number	Open this box:
104564	C/No. 7-1
103967	C/No. 9-1

For the best results and to prevent mixing parts, *assemble each end wall separately* as described below. All bolt tracks in the frame members are installed *to the inside of the greenhouse*. All diagrams and individual photos shown in these end wall instructions show the inside surface of the frame unless otherwise noted.

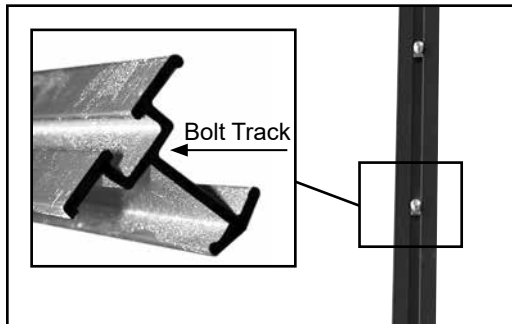

Photo shows vertical frame member for end walls. The bolt track is installed to the inside of the greenhouse.

IMPORTANT: To prevent loosening parts, assemble all frame components on a flat surface. A concrete driveway or a garage floor works best. As you assemble the frame sections, *the inside of the frame will face up* as shown in the photos that follow.

Complete the following steps to assemble the first end wall frame. Consult the End Wall Diagrams near the back of these instructions for part identification *before you begin*.

Assemble the door end first.

1. Open the package for your greenhouse. (See above note if needed.) This package includes the parts to assemble the end wall frames. Consult the End Wall Diagrams for part identification.
2. Locate the top bracket used to join the upper supports to each other at the peak of the end wall.

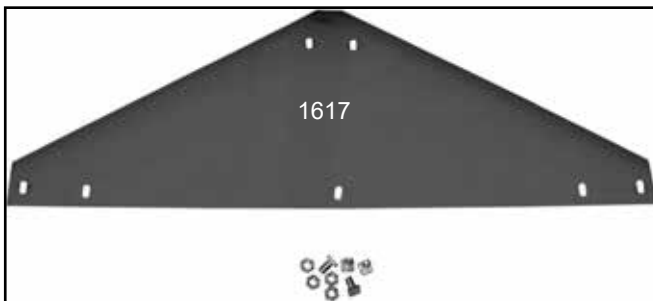

NOTE: The holes in the top bracket are oblong as shown.

3. Locate the two upper supports for the end wall.

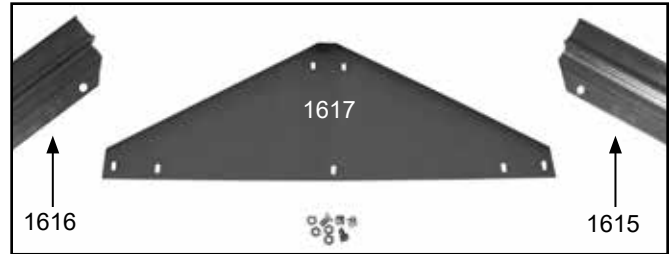

The upper supports include pre-drilled holes, bolt tracks, and a beveled end.

4. With the upper supports positioned as shown below, secure the 1617 bracket to the supports.

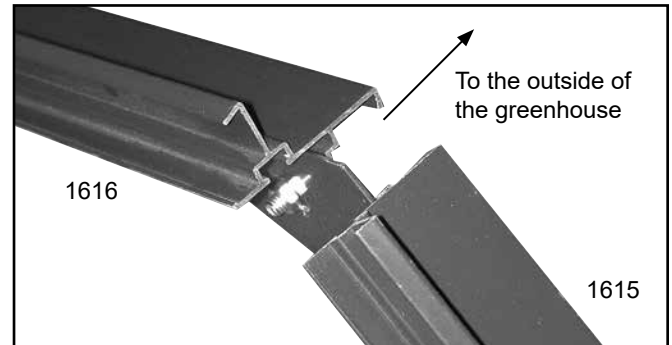

View looking down on the assembled upper supports.

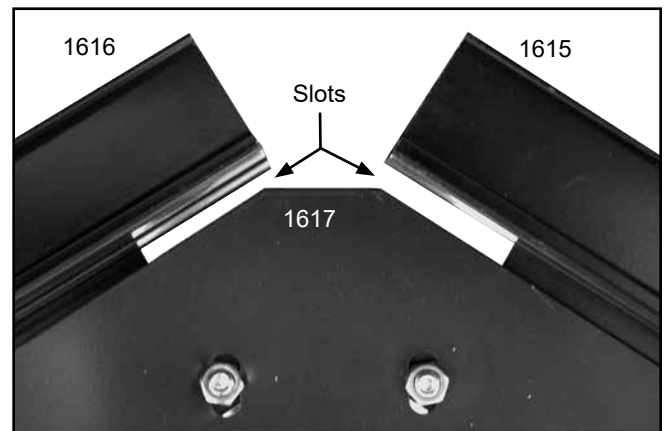

Verify that the slot at the top of each upper support is fully visible before you tighten the bolts to secure the 1617 angled bracket to the upper supports. See the photo above.

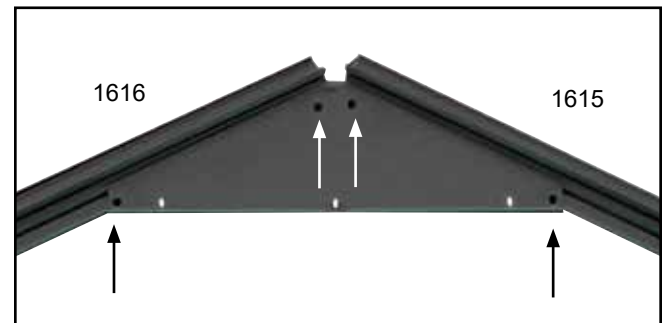

Joined upper supports as seen from the inside of the greenhouse.

GROWSPAN™ ESTATE PRO I GREENHOUSES

ASSEMBLE THE END WALL FRAMES (CONTINUED)

5. Locate one (1) 1618 angled bracket and attach it to the end of one upper support. Do not tighten bolts.

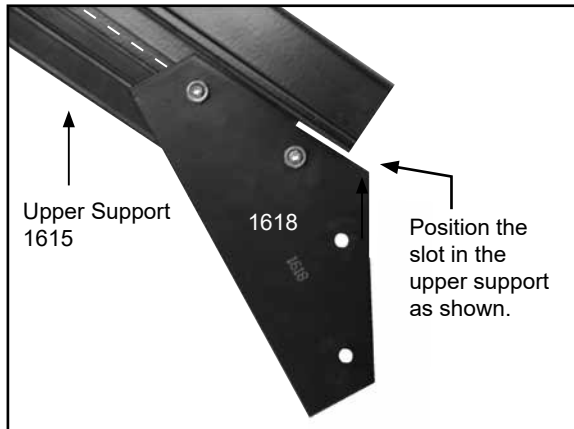

6. Locate another angled bracket and attach it to the end of the *other* upper support. Do not tighten bolts.



The assembled upper end wall frame is shown above and includes the top bracket, two (2) angled brackets, and two (2) upper supports.

7. Select one (1) 1614 lower support and position it as shown below. Align the slots in each frame member.

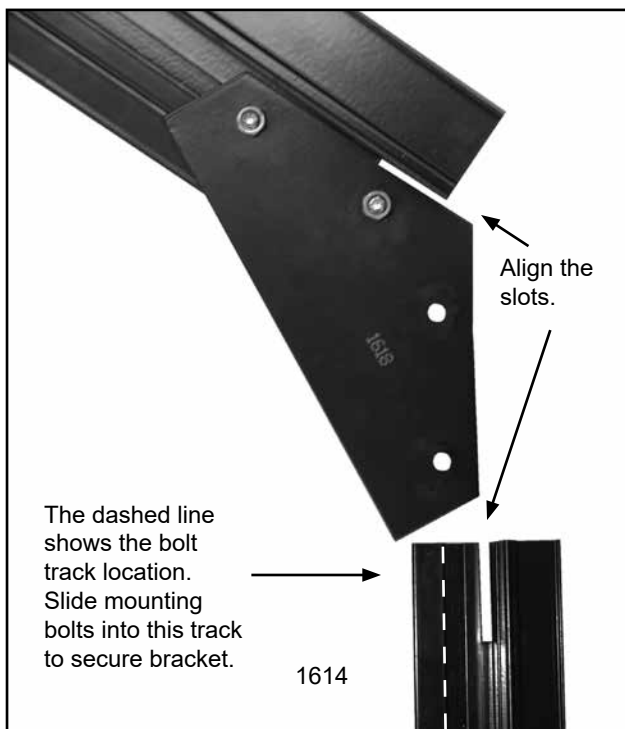

8. Slide two (2) bolts into the bolt track and install the 1618 bracket as shown. *Do not tighten bolts.*

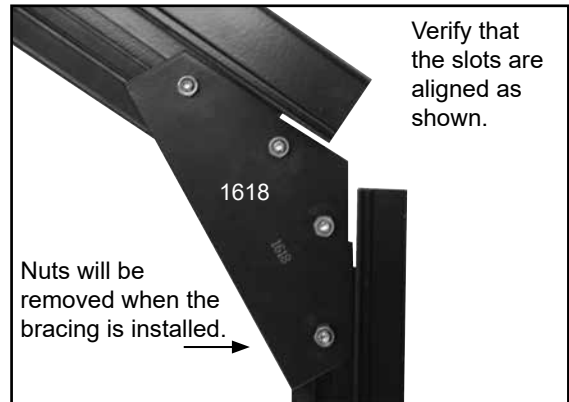

9. Verify that the four bolts are loose and place the template into position as shown in the photos below.

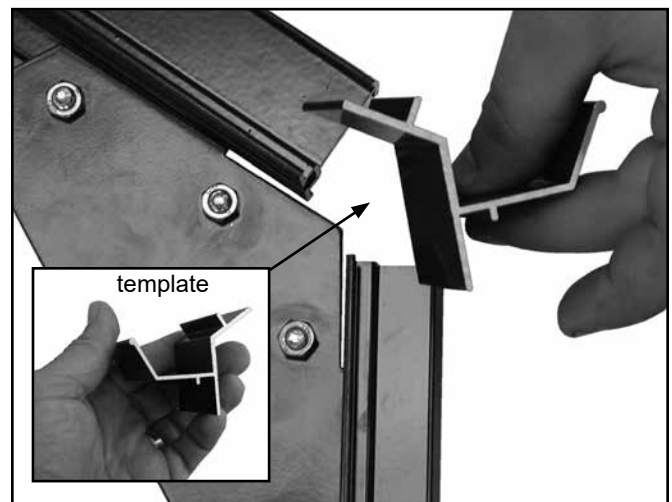

ATTENTION: The template is used to set the proper clearance for the gutter rail. The template slides into the slots in each frame member.

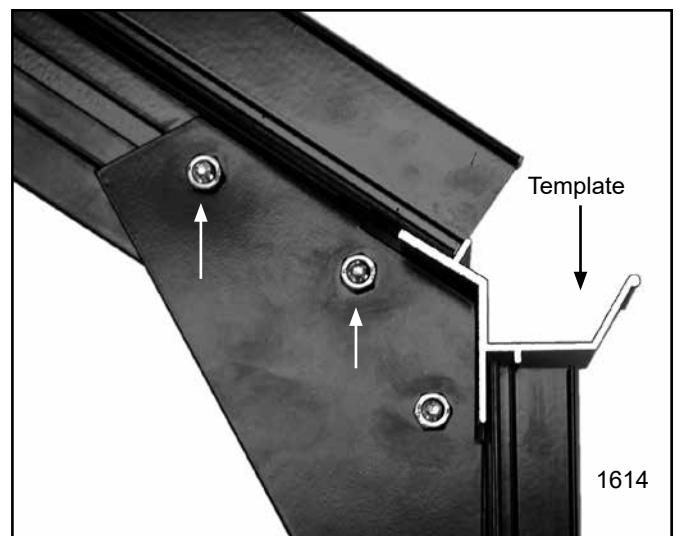

10. With the template in position, tighten the bolts to secure the bracket to the *upper frame member* of the end wall. See the arrows above.

ASSEMBLE THE END WALL FRAMES (CONTINUED)

11. Slightly tighten the lower two bolts and remove the template. These bolts are loosened in a later step to install the end wall horizontal and diagonal bracing.

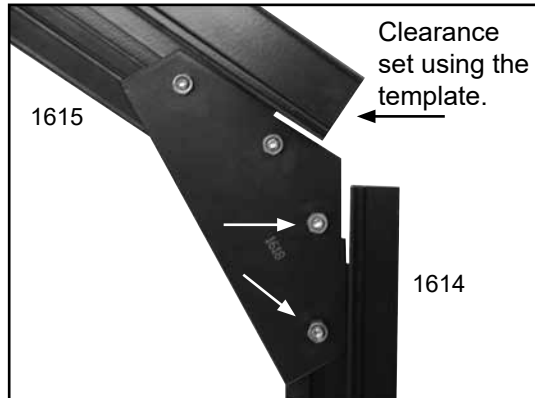

12. Repeat the steps to attach the other 1614 lower end wall support and to set the gutter rail clearance using the template as previously described.

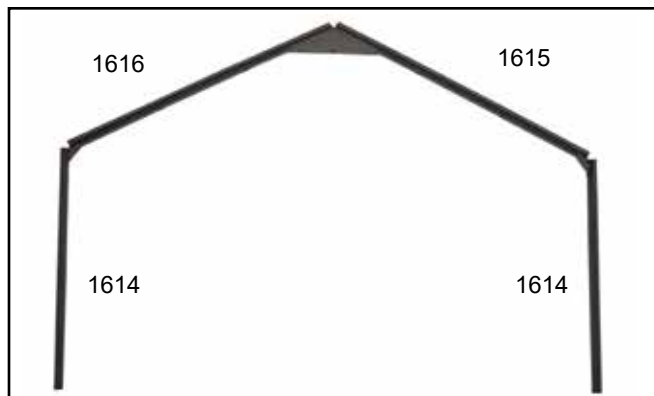
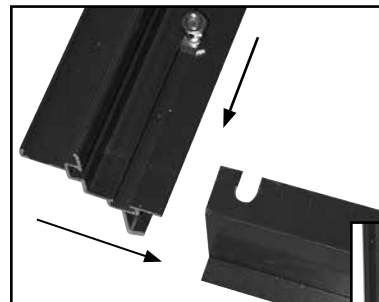
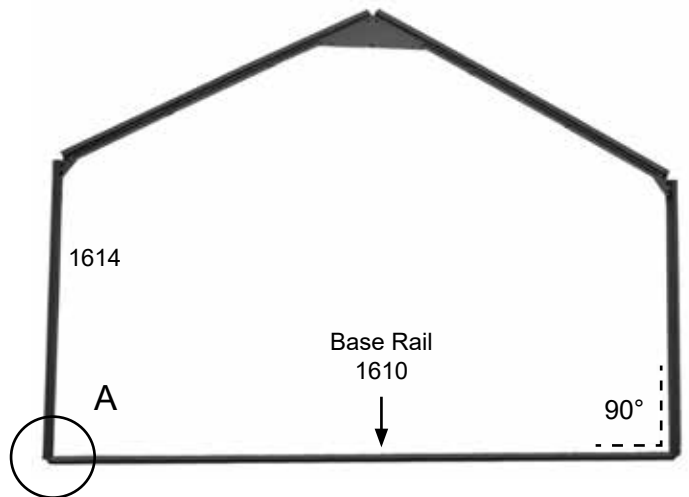
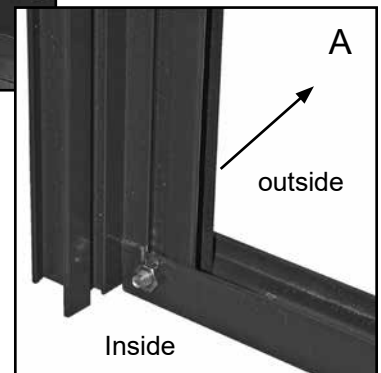

Photo above shows the assembled end wall up to this point. View shows the inside surface of the frame.

13. Locate the base rail (1610) for the end wall and attach it to each of the lower supports as shown below.



ATTENTION: ALL DIAGRAMS AND PHOTOS SHOW THE ASSEMBLY FROM THE INSIDE OR BOLT TRACK SIDE OF THE FRAME DURING ASSEMBLY.



ATTENTION: Seat each lower support tight against the top surface of the base rail.

14. Verify that each lower-support-to-base-rail connection is square and tighten the bolts.
 15. Refer to the End Frame diagram and select the two (2) end wall vertical supports shown below.

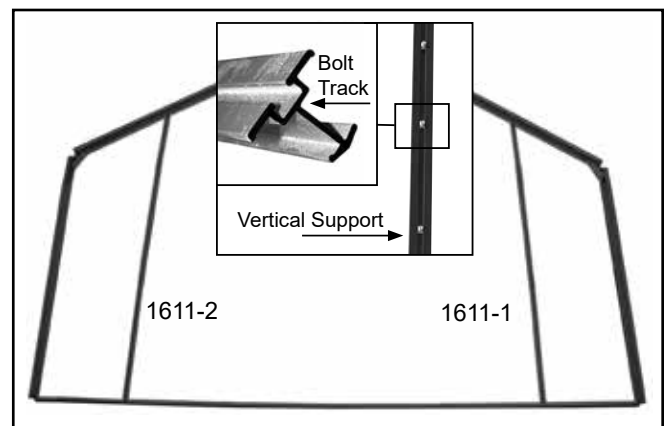

GROWSPAN™ ESTATE PRO I GREENHOUSES

ASSEMBLE THE END WALL FRAMES (CONTINUED)

16. Slide four (4) bolts into the track of each vertical support and attach the top of each support to the upper end wall supports and the bottom of each support to the base rail. Do not tighten these bolts at this time.

ATTENTION: The remaining two (2) bolts in each vertical—those between the top and bottom bolts—are used to secure the short horizontal braces and the diagonal struts. See the End Frame diagrams if needed.

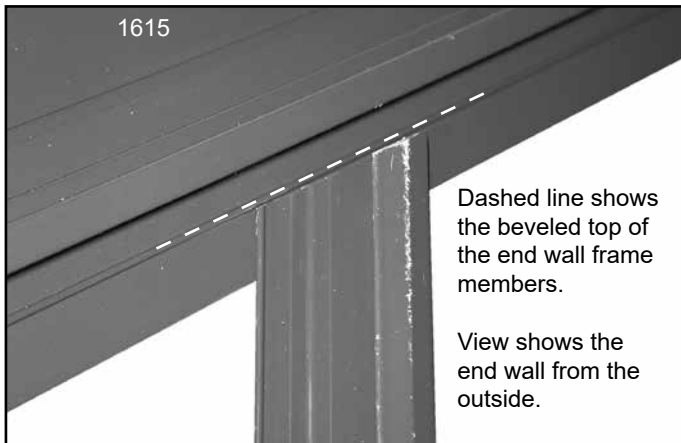

Install the beveled end of the frame member at the top and with the angle of the end wall upper supports.

17. Select the next two (2) vertical supports for the end wall and insert seven (7) bolts into the bolt track of each vertical. (Door end frame only.)

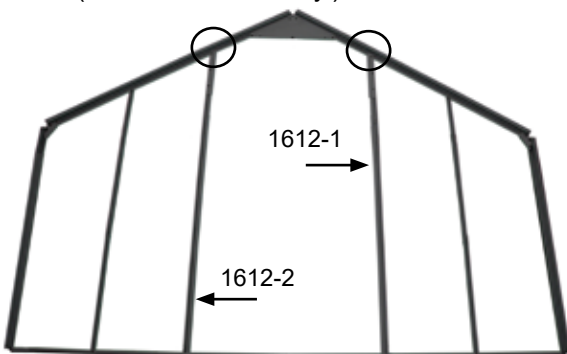

18. Attach each vertical to the upper supports of the frame. See the circles above. Do not tighten bolts.

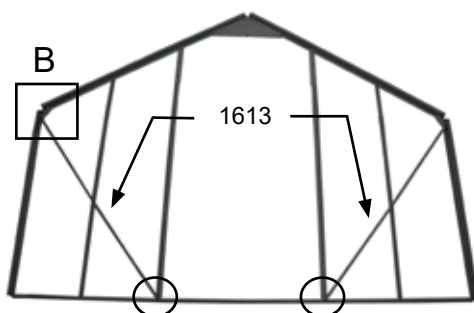

NOTE: After completing this step, each vertical from the previous step should be attached at the top and bottom and five (5) bolts should remain between the top and bottom bolts.

19. Add a diagonal strut to the frame and install the bottom bolts. See the circles above for bolt location.

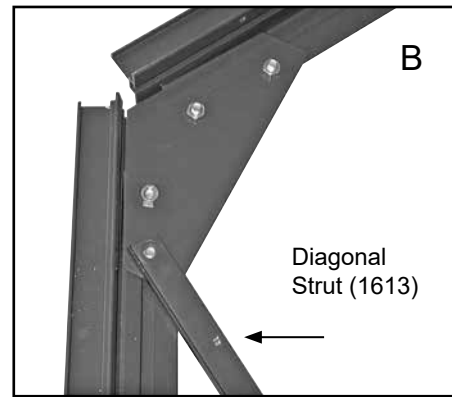

ATTENTION: Do not fully tighten the bolts at this time.

20. Select the 16110 bracket and attach it as shown below using three (3) of the bolts remaining in the bolt track. Tighten the bolts to secure the 16110 bracket to the end wall frame.

21. Repeat the step and attach the remaining 16110 bracket to the remaining vertical frame member.

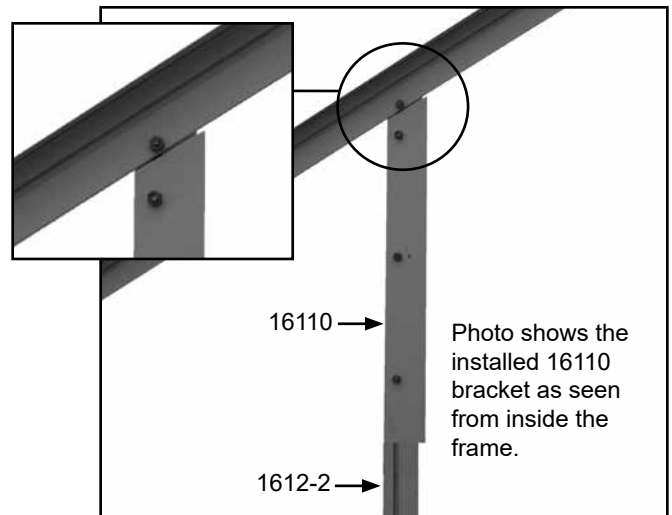

IMPORTANT: At this point, two (2) bolts should remain in each of the vertical frame members. These bolts are used in the next steps.

22. Slide one of the two remaining bolts in the frame member up to the bottom of the 16110 bracket. Repeat this step for the remaining vertical frame member.

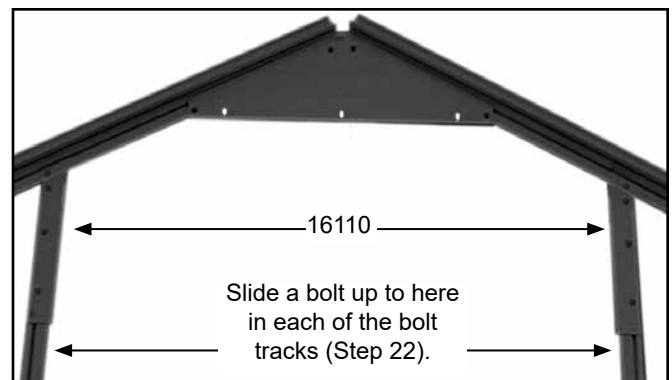

ASSEMBLE THE END WALL FRAMES (CONTINUED)

23. Locate the horizontal braces and attach these to the end wall frame. *Do not use the bolt from Step 22.*

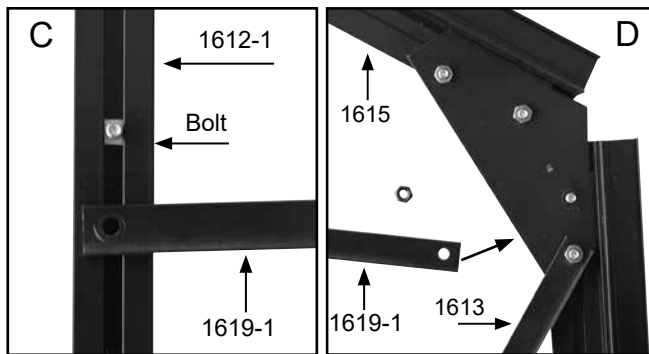
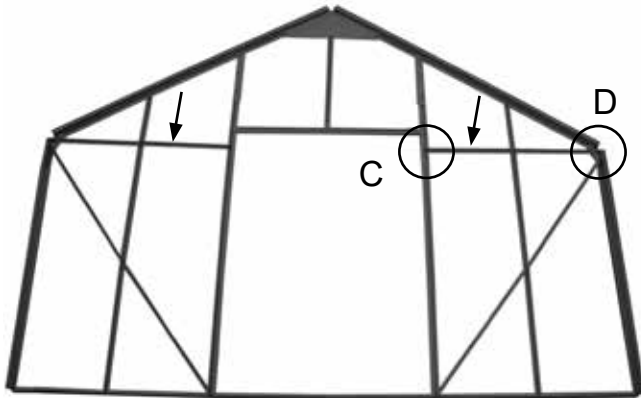

ATTENTION: Use a carpenter's square or similar tool to verify that a 90° angle is maintained at the point where the horizontal brace is attached to the vertical frame members of the end wall. See example below.

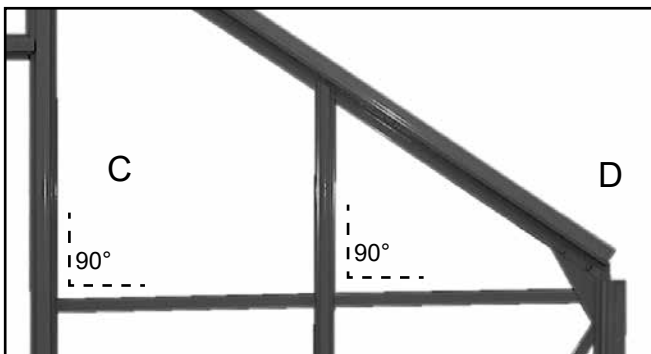

24. Tighten the bolts to secure the horizontal brace to the end wall frame.

25. Repeat the steps to install the remaining brace.

NOTE: At this point, one bolt should remain unused in each of the two frame members. This bolt is used to secure the door header (1665) to the end wall frame.

Verify that one (1) bolt is present to secure each end of the 1665 header. If you need to install or reposition a bolt, loosen the horizontal brace bolts as needed, make the necessary adjustments, and retighten.

- 26. Locate the 1665 header and slide five (5) bolts into the bolt track.
- 27. Attach a 1665-1 flat bracket to each end of the 1665 header. Do not fully tighten the bolts at this time.
- 28. Attach the header and flat brackets between the vertical frame members as shown below.

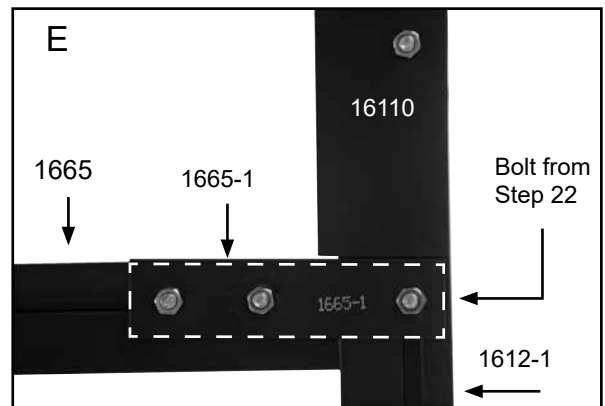
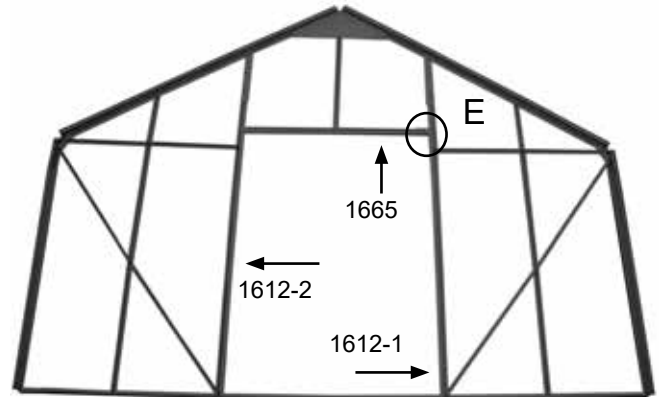

NOTE: Use the final bolt (Step 22) in each of the vertical frame members to secure each 1665-1 bracket.

Do not tighten these bolts at this time.

29. Locate the 1612-3 vertical frame member and attach it between the header and the peak of the end wall.

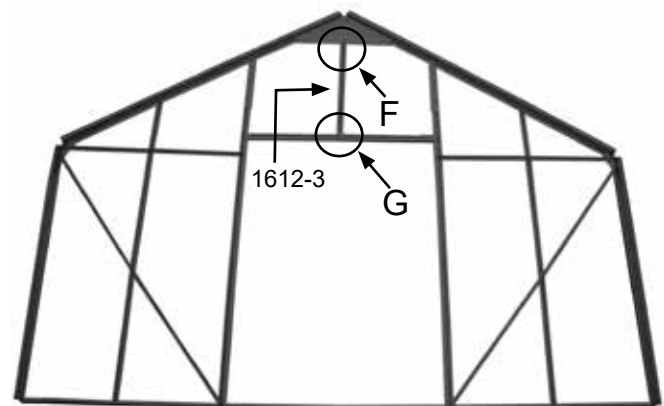

NOTE: Consult the photos on the following page for additional details.

GROWSPAN™ ESTATE PRO I GREENHOUSES

ASSEMBLE THE END WALL FRAMES (CONTINUED)

Space is reserved for customer notes.

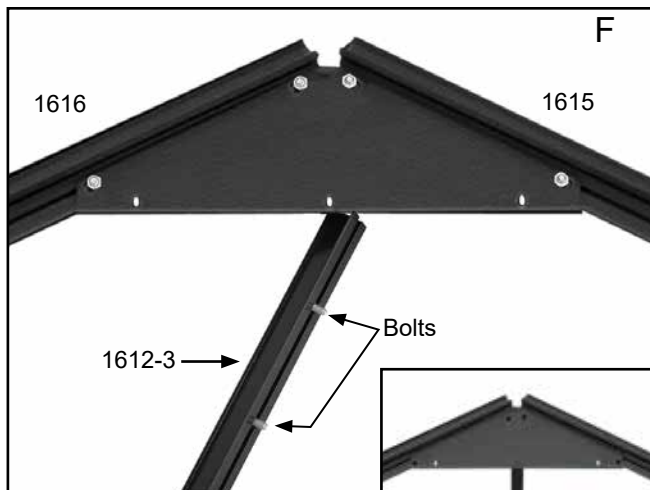

Do not fully tighten the bolts. The header (1665) and the vertical frame member (1612-3) are adjusted and secured when the doors are installed later in these instructions. Bolt should be snug to secure the header.

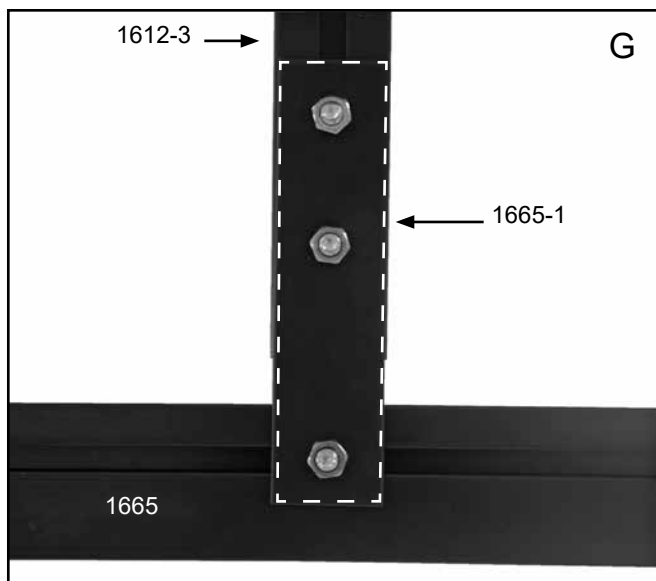

30. After completing the frame for the doors, consult the end wall diagram for the non-door end of the greenhouse and repeat the procedure to assemble that end wall frame.

ATTENTION: The remaining end wall frame does not include an upper door frame member. *In addition, the small horizontal braces of the first end wall frame have been replaced by a single, longer horizontal brace.* Keep these changes in mind as you complete the assembly of the remaining end wall frame.

Consult the diagram near the back of these instructions to view the non-door end wall components.

31. After assembling the end wall frame for the non-door end, set both end wall frames aside and continue with the sidewall assembly procedure that follows.

EXTRA PARTS PROVIDED FOR GREENHOUSE

ATTENTION: TO AVOID TWISTING OFF OR DAMAGING THE FASTENERS, DO NOT OVERTIGHTEN.

FOR YOUR CONVENIENCE, ADDITIONAL FASTENERS AND PLASTIC MOLDING CAN BE FOUND IN THE "EXTRA PARTS" BAG OR BOX.

REFER TO THE BILL OF MATERIALS FOR A LIST OF THE FASTENERS AND MOLDING CONTAINED IN THAT BAG OR BOX.

The plastic profile can be trimmed to the required length if a piece is misplaced or damaged during installation.

IMPORTANT: Consult the "extra parts" for items you need before contacting customer service to request a replacement for damaged or missing parts or fasteners.

SIDEWALL ASSEMBLY: First Two (2) Sections

After both end wall frames are assembled, locate the next box (identified below) for your greenhouse and assemble the first two sections of sidewall framing.

Greenhouse Sku Number	Open this box:
104564	C/No. 7-2
103967	C/No. 9-2

For the best results and to prevent mixing parts, *assemble each side wall separately* as described. All bolt tracks in the frame members are installed *to the inside of the greenhouse*. All diagrams and individual photos shown in these sidewall instructions show the inside surface of the frame unless otherwise noted.

Required parts for the first two (2) sidewall frames:

Part Number	Quantity
1631	6
1632-4	2
1630-4	2
1633	4
Square-Head Bolts (short)	See frame diagram.
Square-Head Bolts (long)	See frame diagram.
Nuts for all bolts	Same as bolt quantity.

HINT: For best results, select the parts using the table above and the sidewall frame diagrams. Position all parts on a flat surface and arrange them according to the sidewall diagram. After the parts are in place, take the required bolts and connect the pieces.

The following steps describe assembling two identical sidewall frames. Complete these steps:

1. Open the box (indicated above) for your greenhouse and, using the table above, gather the parts to assemble the first two (2) sidewall sections.

ATTENTION: PLACE ALL OTHER PARTS BACK INTO THE BOX UNTIL THEY ARE NEEDED LATER DURING THE ROOF ASSEMBLY PROCEDURE.

2. Use the following photos and diagrams to layout and connect the sidewall frame components.

NOTE: It may be necessary to remove or loosen bolts (used during this procedure) when the sidewall frames are attached to the end wall frame.

The two side frames should match when the assembled frames are placed side-by-side with the bolt tracks together.

3. After assembling the first two (2) sidewall frame sections, set them aside and continue with the next procedure to assemble a main frame mid rafter.

Diagrams and Photos for Sidewall Assembly

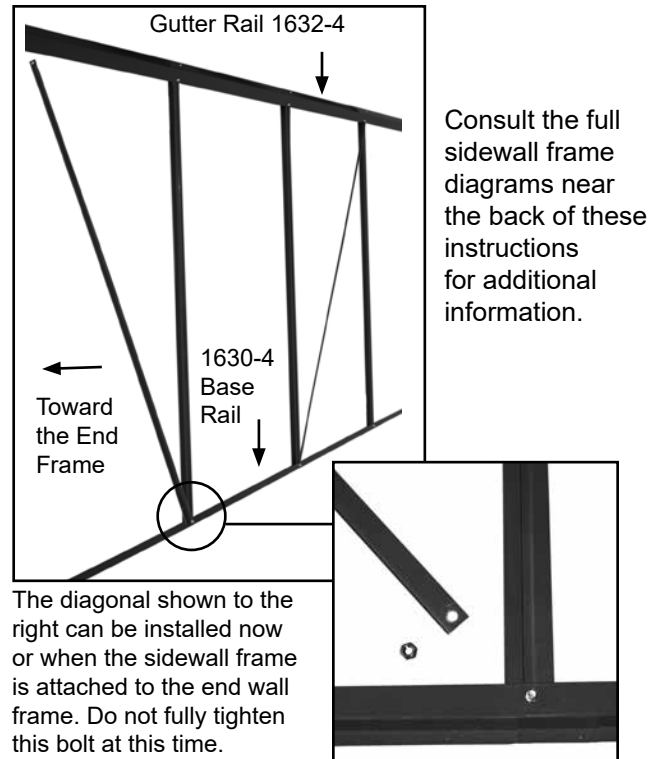

The circles show where to use the longer, square-head bolts. The circle marked with an A (below) shows the long bolt that is slid into the end wall bolt track during the frame assembly.

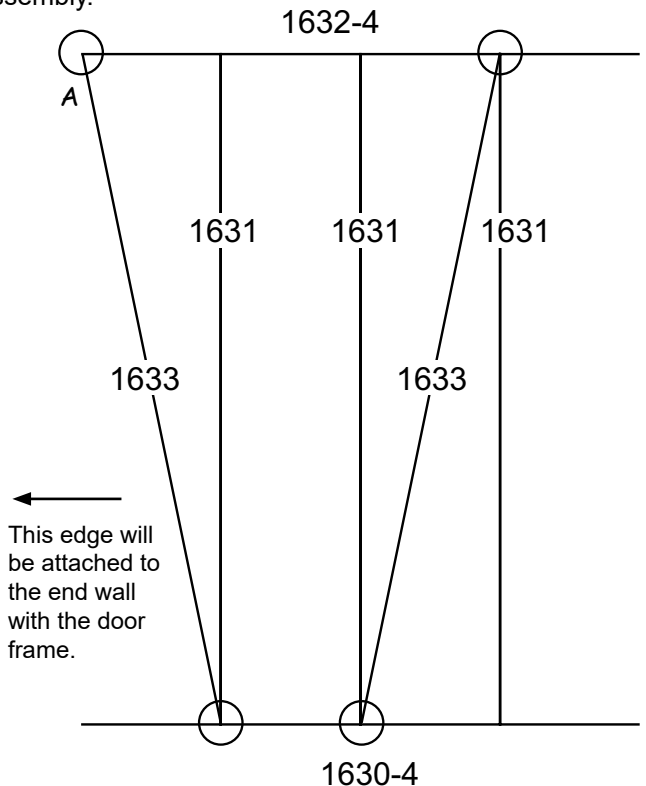

ATTENTION: View of the sidewall is from the inside (or bolt track side) for one side frame and from the outside for the other side frame. When placed together with the bolt tracks inward, the frames match and the diagonals will line up.

GROWSPAN™ ESTATE PRO I GREENHOUSES

ASSEMBLE MAIN FRAME MID RAFTER

The mid rafter (or rafters) for the greenhouse are positioned between the individual sidewall frame sections. Consult the tables that follow and the diagrams to assemble the mid rafter (or rafters) for your greenhouse.

Greenhouse Sku Number	Open this box:
104564	C/No. 7-3
103967	C/No. 9-3

For the best results and to prevent mixing or misplacing parts, remove the necessary parts (identified below) from the box and *assemble the mid rafter* as described.

All diagrams and photos shown in this procedure show the inside (or bolt-track) surface of the mid rafter unless noted. Select these parts to assemble one (1) mid rafter:

Part Number	Quantity
1614	2
1615	1
1616	1
1694	2
1617	1
16100	2
16101	2
16102	2
16103	2
Template	See end frame steps.
Hex-Head Bolts	10
Square-Head Bolts (short)	See photos.
Nuts for all bolts	Same as bolt quantity.

HINT: For best results, position all parts on a flat surface and arrange them according to the photos. After the parts are in place, take the required bolts and connect the parts.

The following steps describe assembling one (1) mid rafter:

1. Open the box (indicated above) for your greenhouse and, using the table, gather the parts to assemble the mid rafter.

ATTENTION: PLACE ALL OTHER PARTS BACK INTO THE BOX UNTIL THEY ARE NEEDED.

2. Use the following photos and diagrams to layout and connect the sidewall frame components.
3. Once the mid rafter is assembled, connect the assembled sidewall frames to the door end wall and then attach the mid rafter to the assembled frame.
4. After the frame assemblies are connected, install the ridge beam as instructed.

Assembled Main Frame Mid Rafter

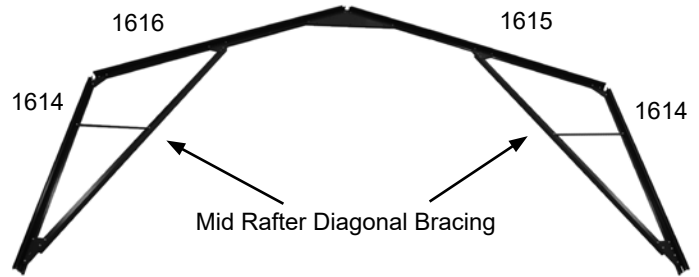

NOTE: The mid rafter is built using the same upper and lower supports found in the end wall framing.

Complete these steps to assemble the mid rafter.

1. Using Steps 2-4 of the *Assemble the End Wall Frames* procedure (Page 7), connect the upper mid rafter components.

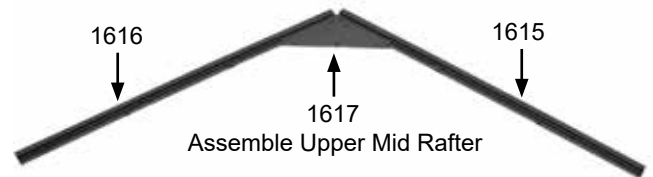

2. Slide four (4) bolts into the bolt track of one upper support. See the next photo. Two bolts are used to attach the diagonal bracing in a later procedure.
3. Using two of the bolts (Step 2), attach the 1694 bracket to the upper and lower support. Photo below shows the assembly of one side of the mid rafter. Use the template to set the proper spacing.

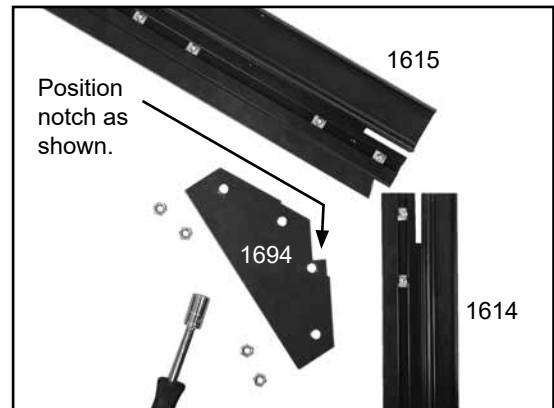

ATTENTION: Verify that the notch shown by the arrow above is positioned as shown.

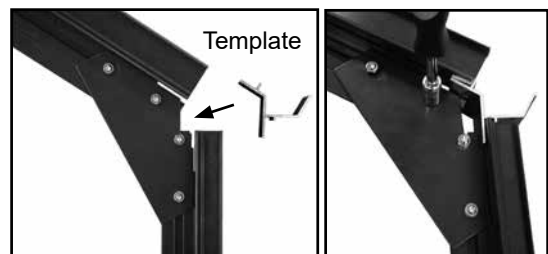

4. Tighten bolts, remove the template, and repeat the steps to attach the remaining 1614 lower support.

ASSEMBLE THE MID RAFTER (CONTINUED)

NOTE: To this point, the mid rafter should resemble the one in the photo below.

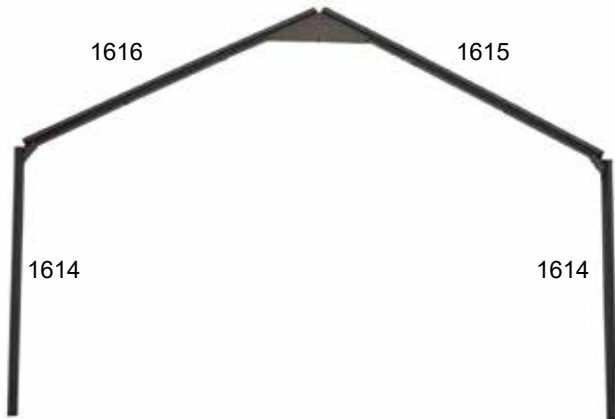

It may be necessary to loosen and reposition some of the brackets during the assembly of the diagonal bracing of the mid rafter.

5. Add the diagonal brackets as shown in the following photos to complete the mid rafter assembly.

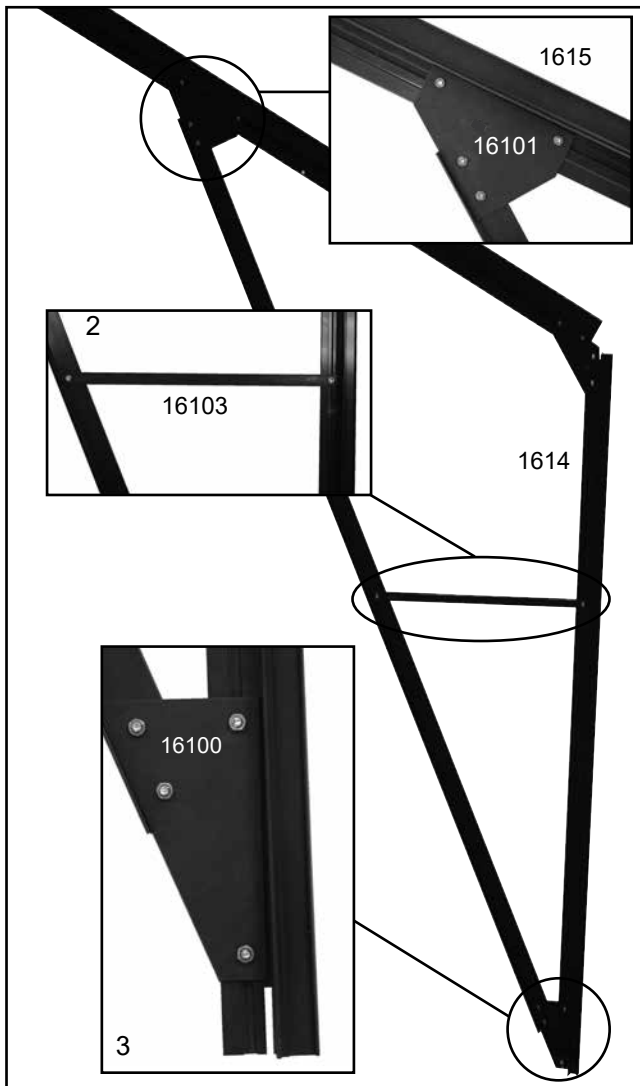

ATTENTION: The photos that follow show how to assemble and attach the diagonal bracing for one side of the mid rafter. *Use the hex-head bolts.*

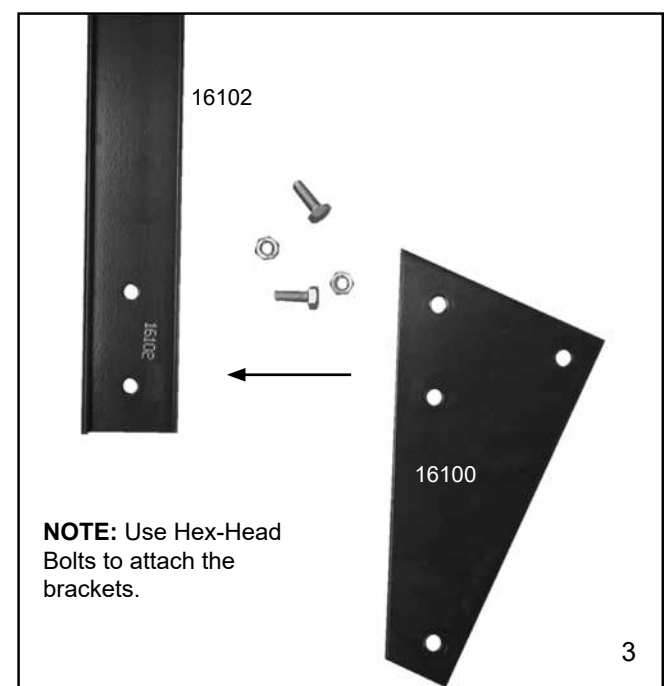
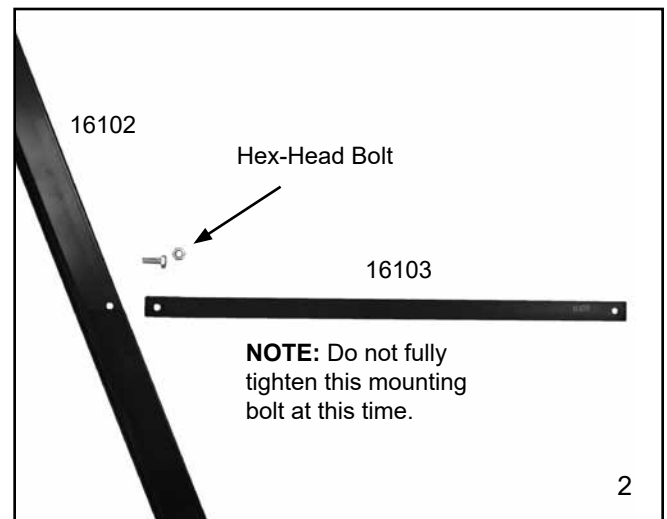
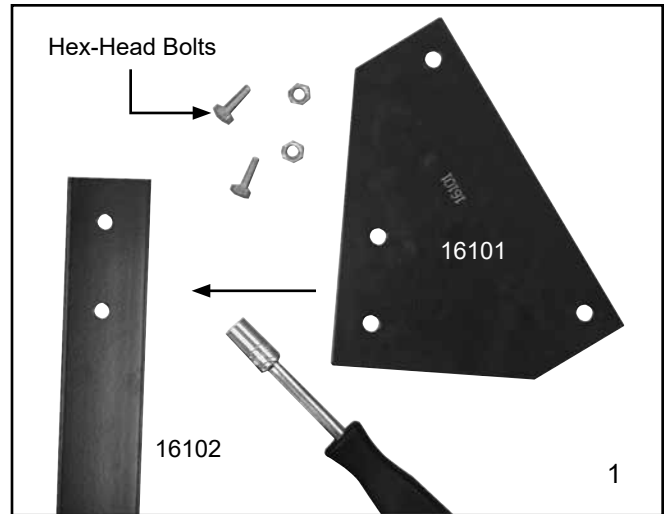

GROWSPAN™ ESTATE PRO I GREENHOUSES

ASSEMBLE THE MID RAFTER (CONTINUED)

- Place the assembled bracing in position and attach it to the upper and lower supports as shown below.

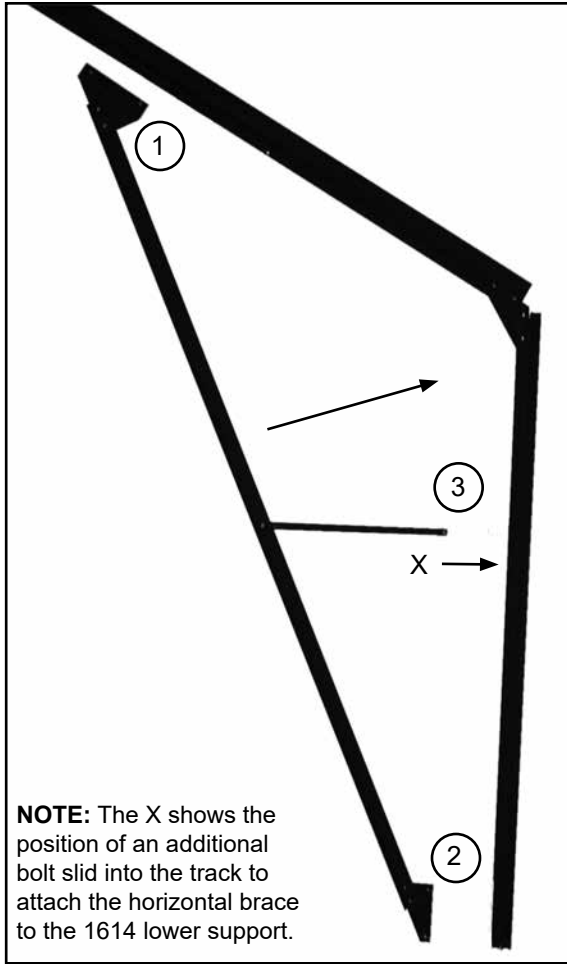

NOTE: Before you attach the lower bracket (2) of the bracing to the support, slide one bolt into the track to attach the horizontal bracing (3).

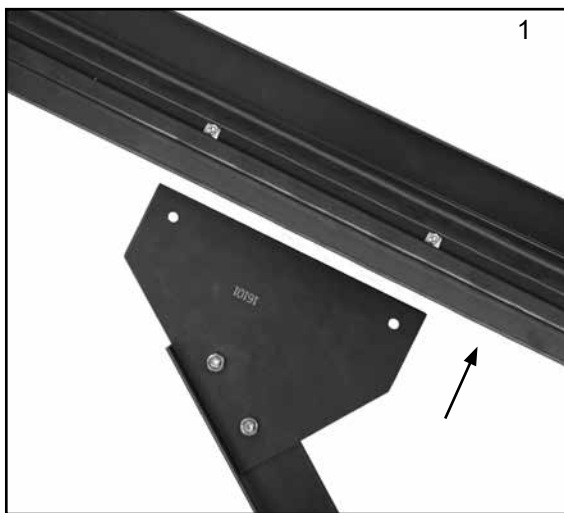

Align the bolts with the bolt holes in the bracket and install the nuts. *Do not tighten at this time.*

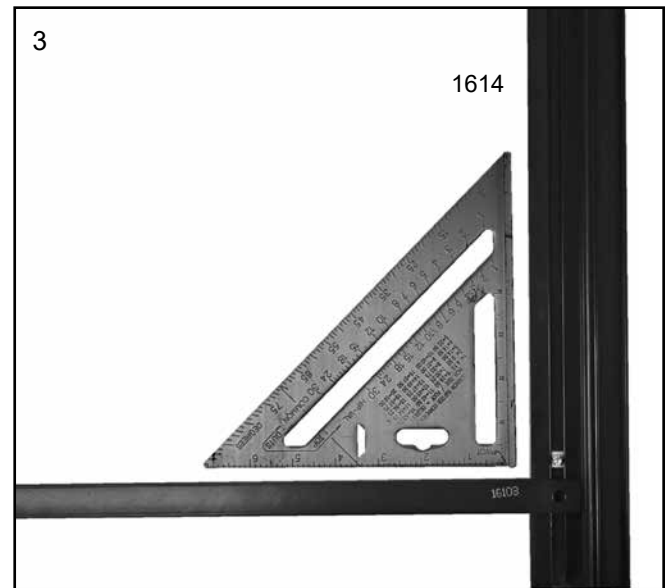
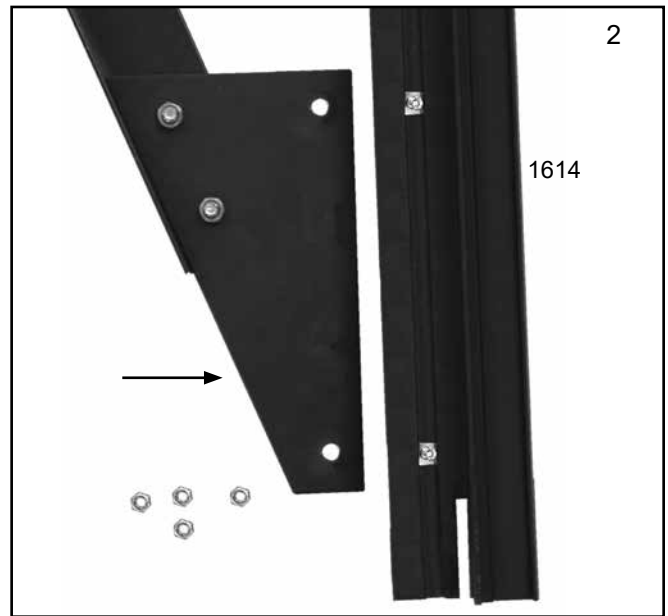

After attaching the assembly, slide it up or down in the track to align the final horizontal brace with the remaining bolt in the track of the 1614 support.

Use a carpenter's square or similar tool to square the connection and tighten all bolts to secure the diagonal brace assembly to the 1614 lower support.

- Repeat the steps to assemble the bracing for the other side of the mid rafter to complete this procedure.
- Once the mid rafter is complete, continue with the next procedure to assemble the first greenhouse section.

ATTENTION: TO AVOID TWISTING OFF OR DAMAGING THE FASTENERS, DO NOT OVERTIGHTEN.

FOR YOUR CONVENIENCE, ADDITIONAL FASTENERS CAN BE FOUND IN THE "EXTRA PARTS" BAG OR BOX. REFER TO THE BILL OF MATERIALS FOR A LIST OF THE FASTENERS CONTAINED IN THAT BAG OR BOX.

ASSEMBLE THE FIRST GREENHOUSE SECTION

The following steps describe how to connect the greenhouse components you have assembled up to this point. These steps are repeated as other greenhouse sections are added.

ATTENTION: For best results, connect the assembled greenhouse sections on a flat surface as shown.

Required parts to complete these steps:

- Assembled end wall (door end)
- Assembled sidewall frames (2)
- Assembled mid rafter (1)
- Ridge Beam (1650-4) from Box 7-2 (SKU: 104564) or 9-2 (SKU: 103967)
- Square-head bolts from Box 7-2 (SKU: 104564) or 9-2 (103967)

After the above sections are connected, the greenhouse will appear as shown in this diagram:

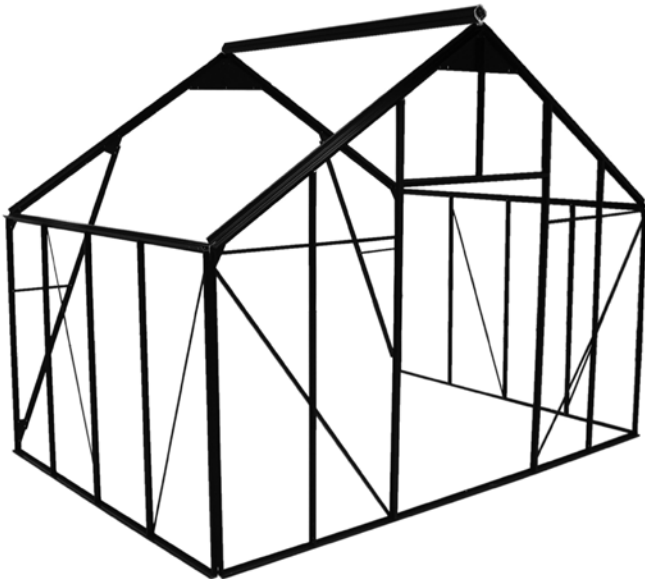

Complete the following steps.

1. Position the assembled frame sections as shown below with the bolt tracks or inside surface facing up.

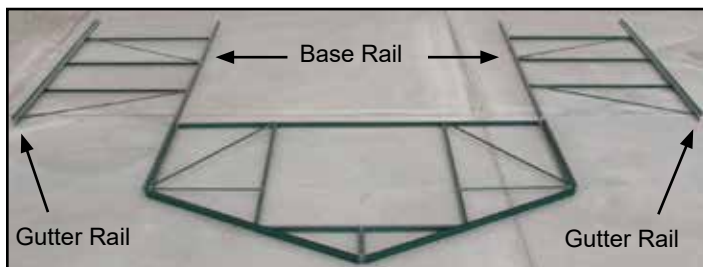

NOTE: Some frame photos may be of a different model. *The assembly process is the same.*

2. With assistance, lift the end wall and first sidewall frame into position as shown.

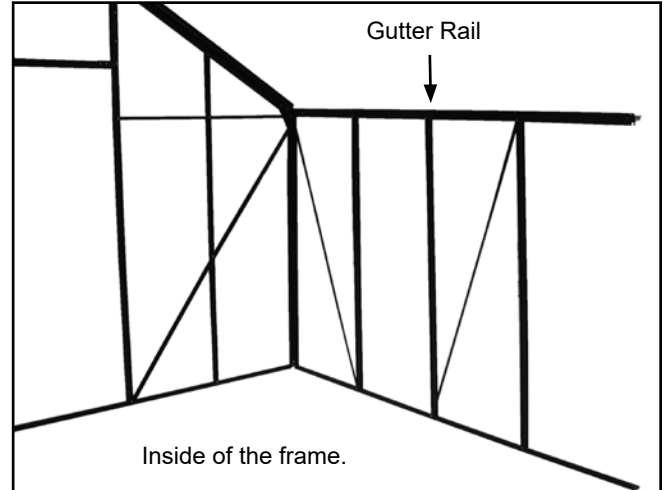

3. Slide a *long bolt* into the bolt track of the lower support (1614) of the end wall. Use a piece of tape to keep it from dropping to the bottom if desired.

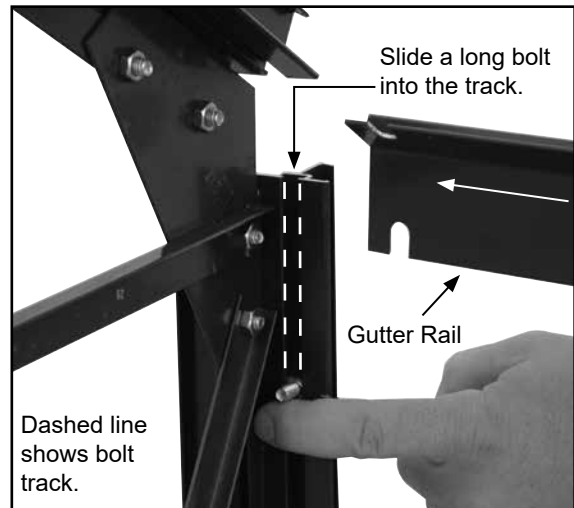

4. Slide a short bolt and nut into the bolt track of the *upper support*, align the slot in the base rail with the bolt track in the upper support, and tighten the upper bolt.

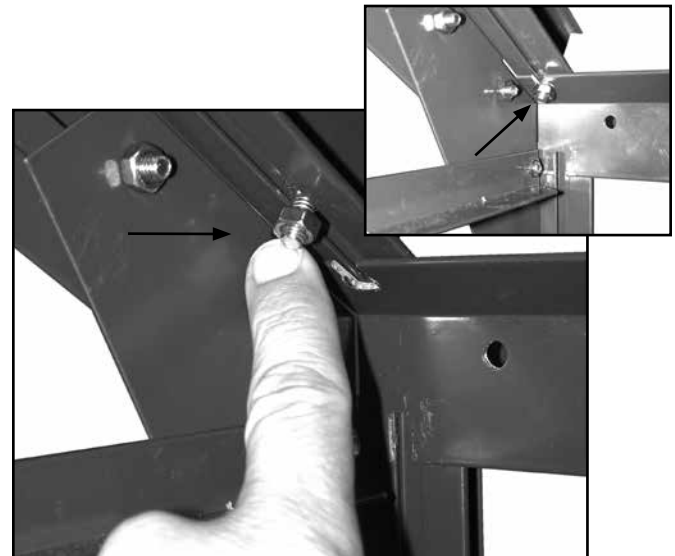

GROWSPAN™ ESTATE PRO I GREENHOUSES

ASSEMBLE THE FIRST GREENHOUSE SECTION (CONTINUED)

5. Detach the diagonal brace of the sidewall frame *at the base rail location* (if needed) and slip the upper end of the brace over the long bolt installed earlier in Step 3.

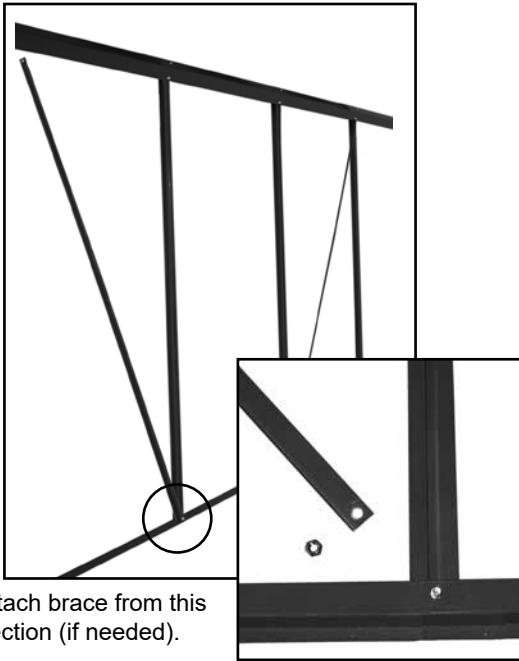

A. Detach brace from this connection (if needed).

- B. Slide long bolt into position.

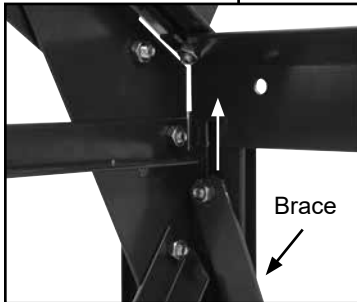
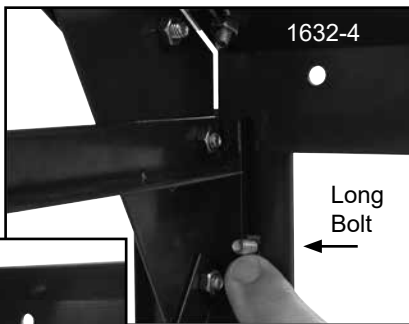

C. Place upper end of brace on the long bolt and add nut.

- D. Slide the brace and bolt up into the slot of the gutter rail.

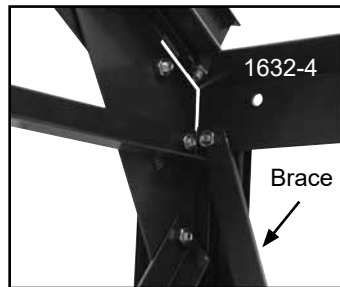

6. With the upper end of the sidewall diagonal brace in position, reattach the lower end to the base rail and tighten both the upper and lower end bolts.

NOTE: View below shows the corner connection from the outside of the frame.

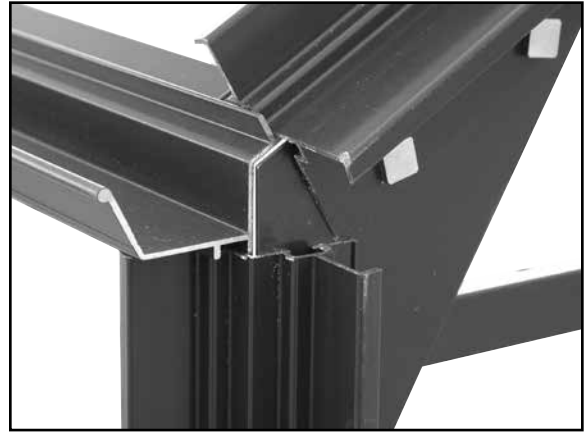

7. Move to the sidewall base rail, slide a bolt into the bolt track of the 1614 lower support (if needed), and secure the support to the base rail.

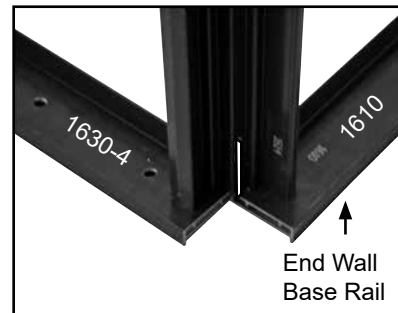
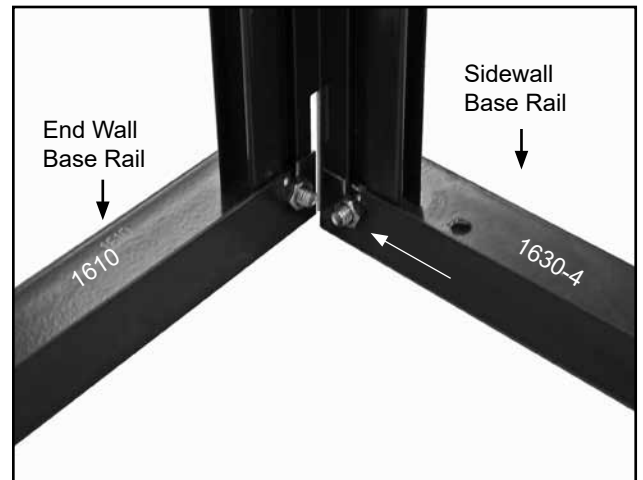

View (left) shows the same corner from the outside.

View (right) shows the frame assembly up to this point.

View shows the backside or inside surface.

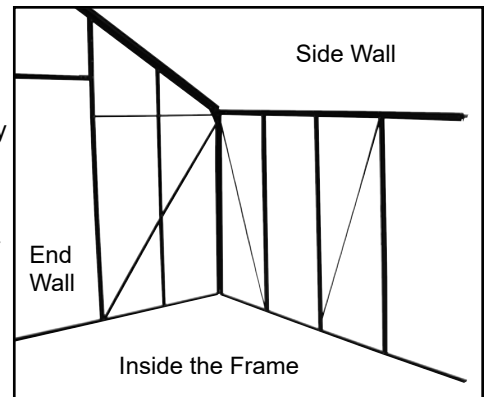

ASSEMBLE THE FIRST GREENHOUSE SECTION (CONTINUED)

- Repeat the steps to secure the remaining sidewall frame to the end wall frame.

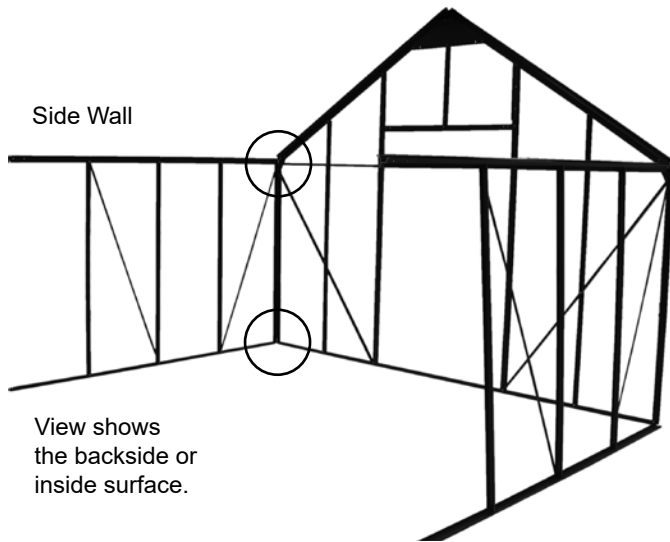

NOTE: Circles indicate where to secure the sidewall frame to the end wall as describe earlier.

- Recheck all bolts to verify they are tight.
- Brace the sidewalls so they stay in position and continue by attaching the assembled mid rafter.

ATTACH THE ASSEMBLED MID RAFTER

After installing the first two sidewall frames, attach the assembled mid rafter to the frame as described below.

- Place the assembled mid rafter in line with the frame as shown.

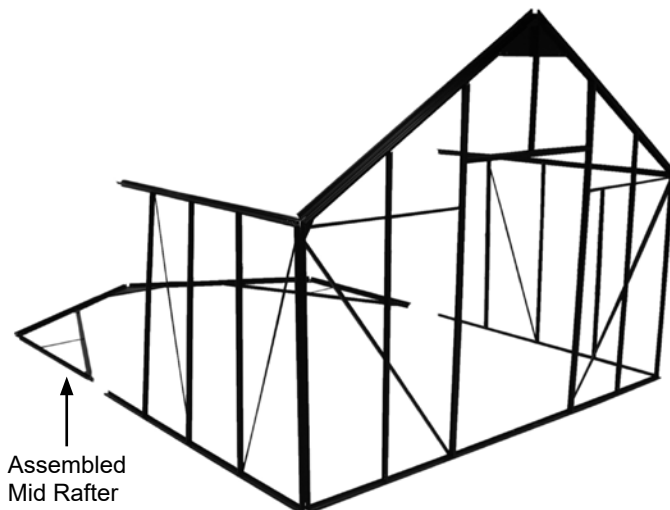

ATTENTION: The bolt tracks of the lower 1614 supports must face up to attach the mid rafter to both sidewall frames.

- With assistance, lift the mid rafter into position



- Align the bolt tracks of the rafter with the slots in the gutter rail of the sidewall frame as shown.



- Slide a bolt and nut into the bolt track of the mid rafter. See the circles above. Use tape or slightly tighten the nut to keep the bolt from sliding out of the track.

GROWSPAN™ ESTATE PRO I GREENHOUSES

ATTACH THE ASSEMBLED MID RAFTER (CONTINUED)

- Secure the rafter to the side wall using the bolts that were installed earlier.

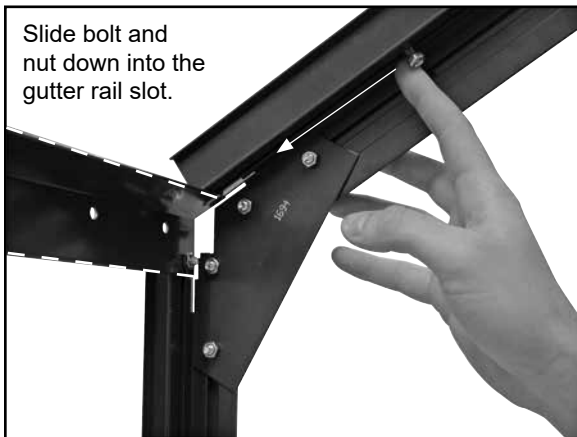
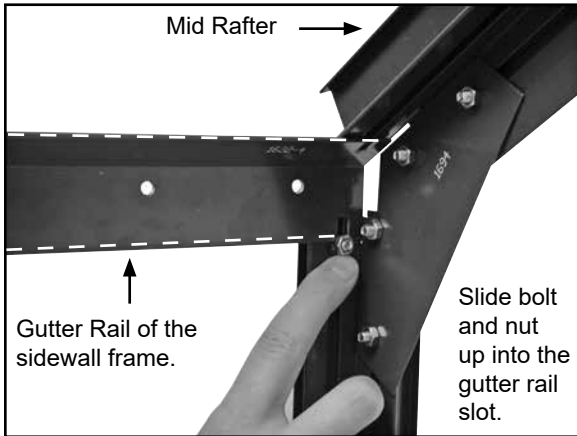

NOTE: Dashed lines indicate the position of the gutter rail, which is against the mid rafter bolt tracks.



- Repeat the steps to attach the other mid rafter support to the remaining sidewall frame.

- Verify that all bolts are tight.

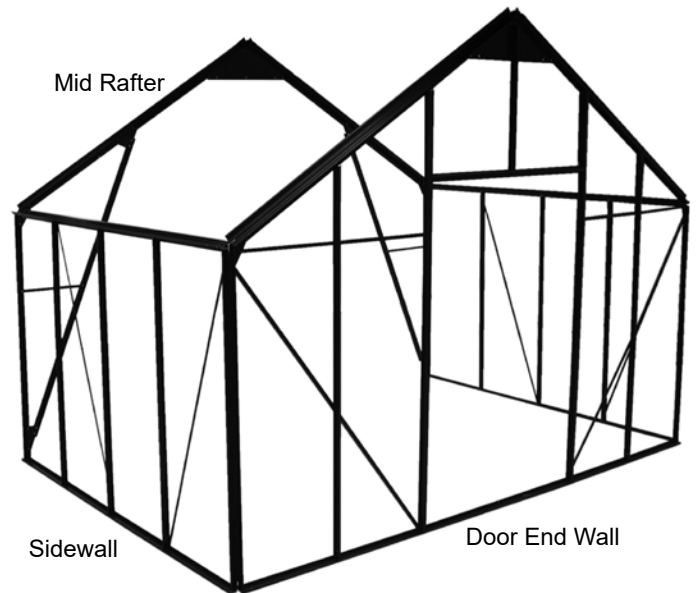

NOTE: The assembled frame up to this point is shown above.

- Continue with the installation of the first ridge beam (1650-4).

INSTALL THE RIDGE BEAM

Depending on the length of the greenhouse the ridge beam (1650-4) may be shipped in two or three identical sections.

For this procedure, only one section is installed. The remaining section or sections are installed as the frame assembly continues.

IMPORTANT: Consult the ridge beam note on the next page for box location of the ridge beam.

The parts required for this procedure include:

Part Number	Quantity
16506 (bracket)	2
Hex-Head Bolts	8
Square-Head Bolts (short)	4
Nuts for square-head bolts	4

NOTE: These parts are found in the following box for the selected greenhouse:

Greenhouse Sku Number	Work from this open box:
104564	C/No. 7-3
103967	C/No. 9-3

Continue with the procedure on the following page to install the ridge beam (1650-4).

INSTALL THE RIDGE BEAM (CONTINUED)

Complete the following steps to install the ridge beam.

RIDGE BEAM NOTE: Choose the 1650-4 ridge beam from Box 7-2 for greenhouse 104564 and from Box 9-2 for greenhouse 103967. (All ridge beams are identical.)

1. Remove the 1650-4 ridge beam from the correct box and install the brackets (16506) as shown.

A. Collect the parts.

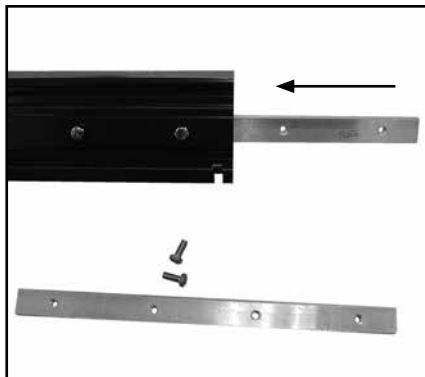
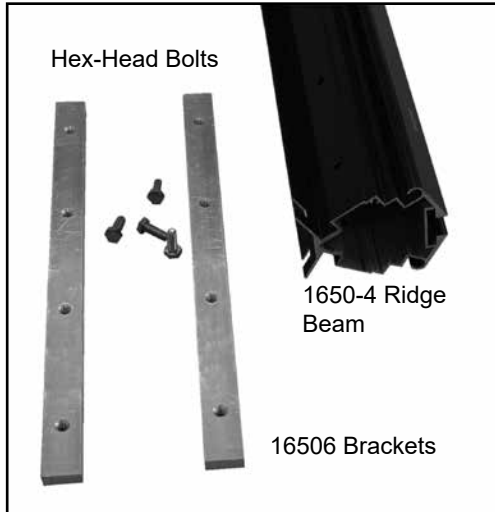

B. Insert the 16506 brackets into the beam and thread the hex-head mounting bolts into the bracket.

Brackets are used to connect the ridge beam to the next ridge beam.

C. Slightly tighten the mounting bolts.

These may need to be loosened when the next ridge beam is added.



NOTE: Do not fully tighten the bolts at this time. Bolts are tightened when the next ridge beam is installed.

2. Take two (2) square-head bolts with nuts and *slide one (1) into each bolt track* of the upper supports as shown in the next diagram.

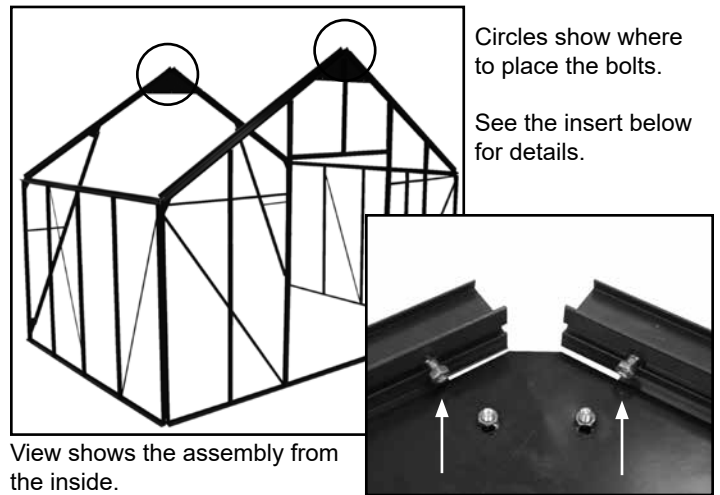

View shows the assembly from the inside.

NOTE: Bolts will *slide* to the bottom of the track. Use a small piece of tape or slightly tighten the nuts to keep the bolts near the peak.

3. With assistance, lift the ridge beam into place.

NOTE: Attach the end, which is without the brackets, to the end wall frame.

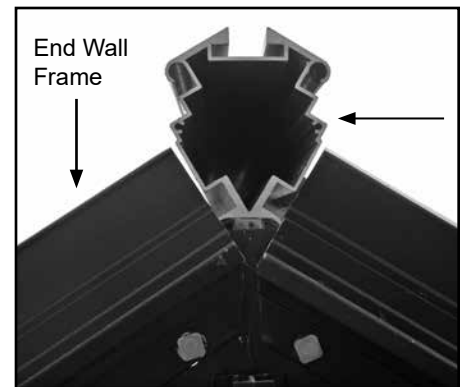

View shows the end wall *from the outside*.

4. With the ridge cap in place, tighten the bolts.

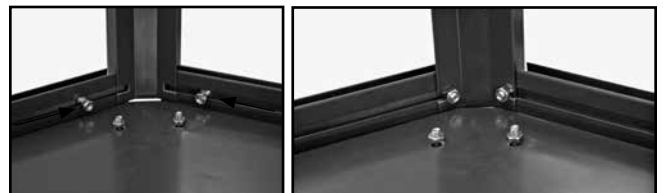

Diagrams above show the underside of the ridge beam. The assembled frame to this point is shown in the diagram below.

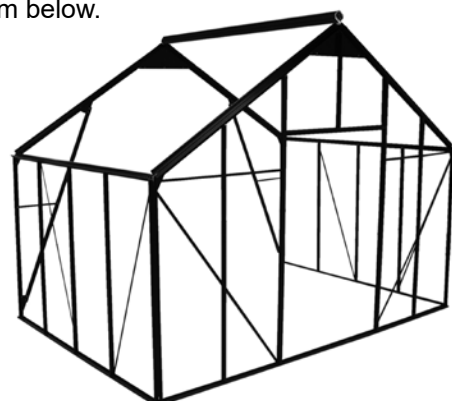

5. Assemble the next section of sidewall frame.

GROWSPAN™ ESTATE PRO I GREENHOUSES

ASSEMBLE NEXT 2 SECTIONS OF SIDEWALL FRAME

With the first section of greenhouse frame assembled, construct the next two (2) side wall sections.

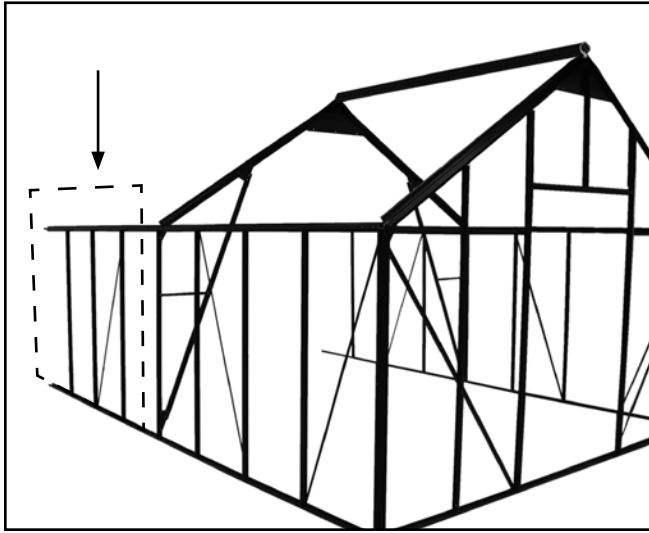

Dashed line above shows the next sidewall frame section to be assembled. (The adjacent side is not outlined.) The parts for this procedure are found in the box identified in the table below for the selected greenhouse:

Greenhouse Sku Number	Work from this open box:
104564	C/No. 7-3
103967	C/No. 9-3

Consult the table below and the sidewall diagrams and collect the parts needed to assemble the next two (2) sidewall frame sections:

Part Number	Quantity
1631	6
1632-4	2
1630-4	2
1633	4
Square-Head Bolts (short)	See frame diagram.
Square-Head Bolts (long)	See frame diagram.
Nuts for all bolts	Same as bolt quantity.

Complete these steps to assemble the sidewall frame sections:

1. Consult the diagram in the next column to arrange the parts as shown.
2. Refer to the previous sidewall frame instructions to construct these two (2) sections of sidewall framing.
3. Place the assembled frames as shown in the diagram to the right.
4. Continue by attaching these sidewall frames to the assembled main frame.

The circles show where to use the longer, square-head bolts.

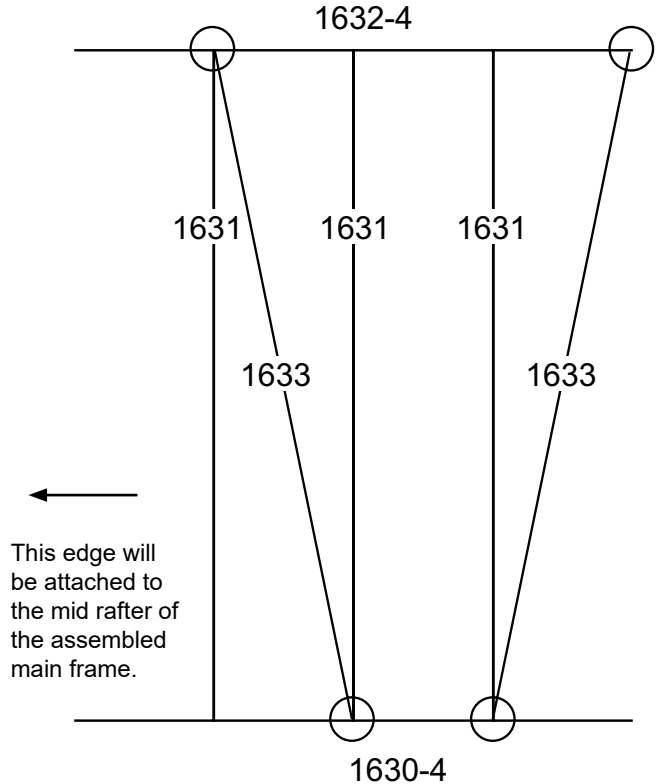

ATTENTION: View of the sidewall is from the inside (or bolt track side) for one side frame and from the outside for the other side frame. When placed together with the bolt tracks inward, the frames match and the diagonals will line up.

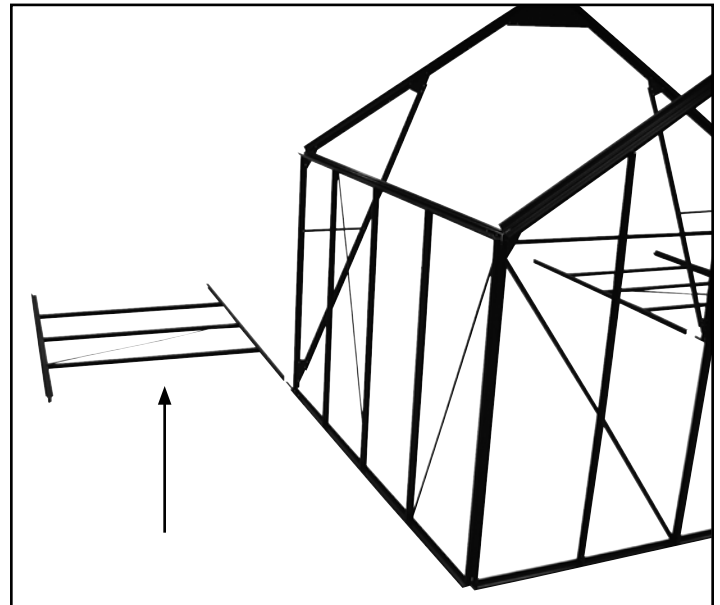

NOTE: The end diagonal brace is not shown. It is installed after the sidewall frames are attached to the main frame.

ATTACH THE SIDEWALL FRAMES TO MAIN FRAME

These sections of sidewall frames are attached to the main frame using special brackets. Consult the following table to select the parts to complete these steps.

Part Number	Quantity
16306	2
16326	2
Phillips Pan-Head Screws	8
Hex-Head Bolts	16
Nuts for all bolts	16

The parts for this procedure are found in the box identified in the table below for the selected greenhouse:

Greenhouse Sku Number	Work from this open box:
104564	C/No. 7-3
103967	C/No. 9-3

Complete these steps:

1. Take the 16306 brackets and four (4) of the Phillips screws and attach one (1) bracket to *each base rail of the assembled main frame*.

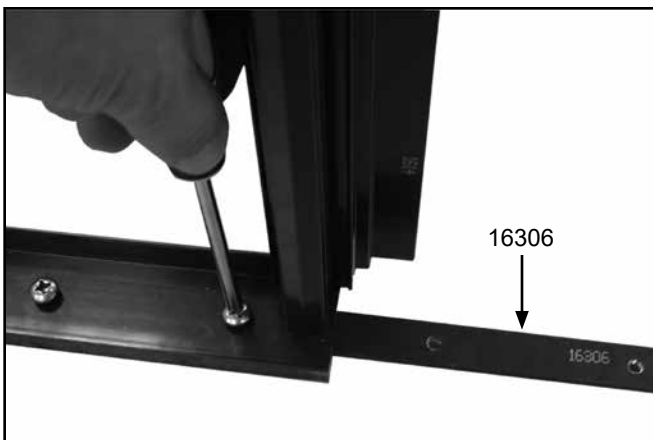
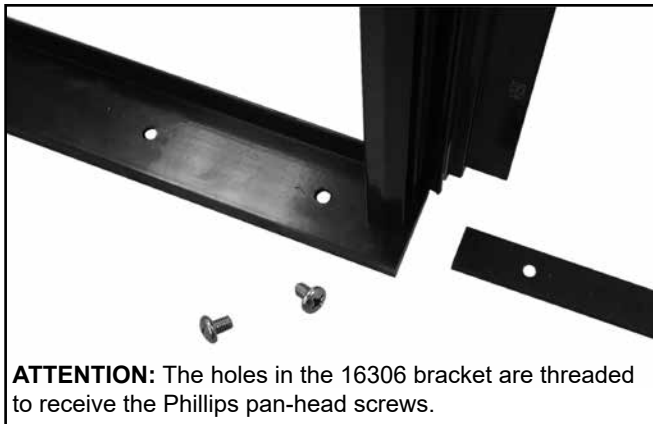

NOTE: These brackets are used to secure the separate sidewall sections together.

2. With assistance, set the sidewall frame in position.



3. Slide the sidewall frame onto the 16306 bracket attached to the main frame and secure it in place using the Phillips pan-head screws.

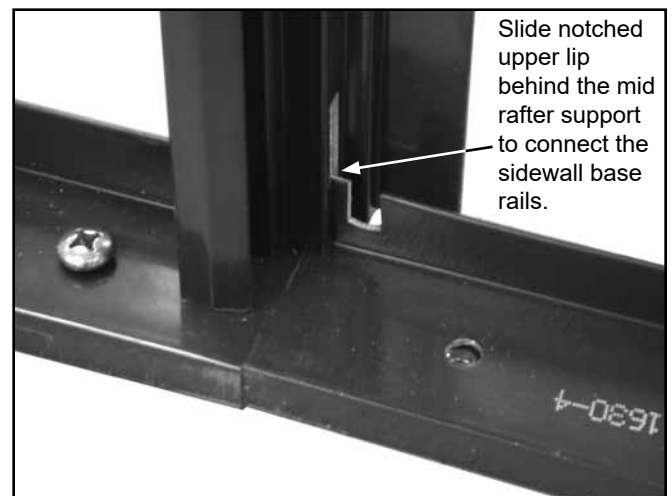

NOTE: Verify that the joint between the two base rails is tight. The notched upper lip of the base rail slides behind the lower support of the mid rafter.



GROWSPAN™ ESTATE PRO I GREENHOUSES

ATTACH SIDEWALLS (CONTINUED)

4. Take two (2) 16326 brackets and eight (8) hex-head bolts and nuts and secure the sidewall gutter rails as described and as shown.

16326 Brackets



ATTENTION: The holes in the 16326 brackets are not threaded. Use the hex-head bolts and nuts to secure the brackets.

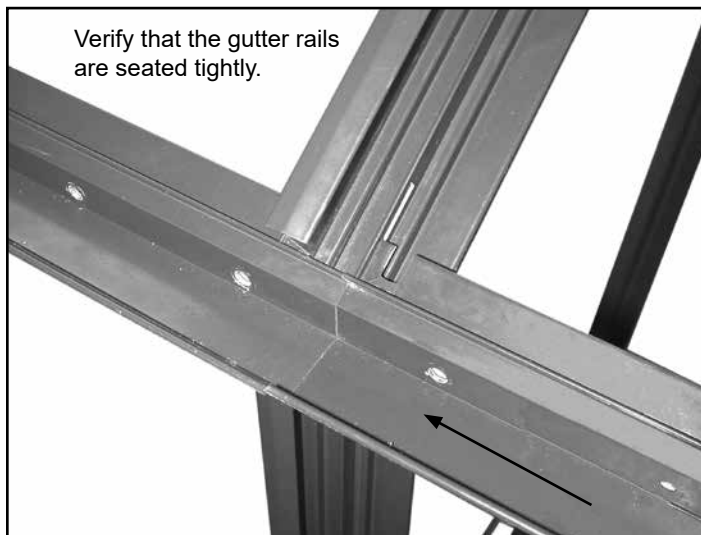

Attach the 16326 bracket to the outside of the gutter rails. Add the hex-head bolts and nuts and tighten. Install the nuts on the outside as shown or on the inside if desired.

Move to the inside of the frame and slide the 16326 bracket between the gutter rail and mid rafter.



Secure the bracket to the gutter rails using the hex-head bolts.



5. Repeat the steps to attach the remaining sidewall frame to the main frame as previously described.
6. After attaching both sidewall frame sections, continue with the procedure that follows on the next page for the selected greenhouse.

For the 104564 greenhouse, continue with the steps that follow the 104564 GREENHOUSE heading.

For the 103967 greenhouse, continue with the steps that follow the 103967 GREENHOUSE heading.

ATTENTION: TO AVOID TWISTING OFF OR DAMAGING THE FASTENERS, DO NOT OVERTIGHTEN.

FOR YOUR CONVENIENCE, ADDITIONAL FASTENERS CAN BE FOUND IN THE "EXTRA PARTS" BAG OR BOX. REFER TO THE BILL OF MATERIALS FOR A LIST OF THE FASTENERS CONTAINED IN THAT BAG OR BOX.

104564 GREENHOUSE

After installing the last two (2) sections of sidewall framing, take the assembled end wall frame (no door) and attach it to the end of the main frame. Complete these steps:

1. Consult the previous "**Assemble the First Greenhouse Section**" procedure if needed to view the details for attaching a sidewall frame to an end wall frame.

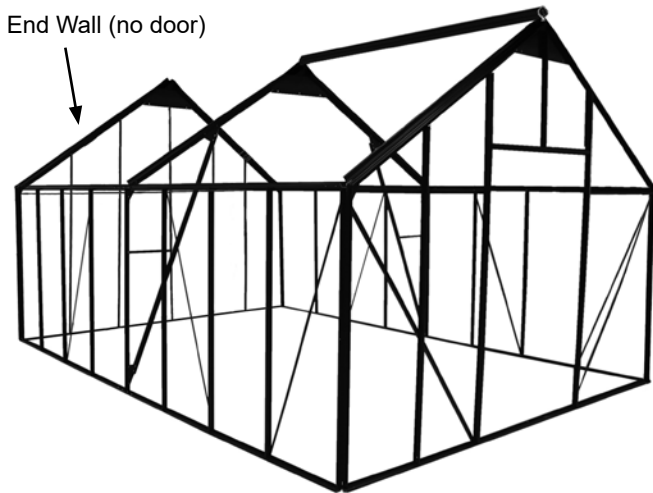

2. After attaching the sidewall frames to the final end wall frame, install the final section of 1650-4 ridge beam.

The beam is found in Box 7-3 for 104564. Use the previous "Install Ridge Beam" instructions to set the final ridge beam (1650-4) on the frame and to attach it to the installed ridge beam and to the frame. Consult the diagrams below for details.

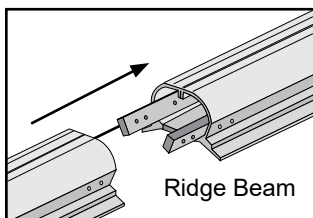

NOTE: Diagram may show a ridge beam that differs in design from actual beam. Brackets are the same however.

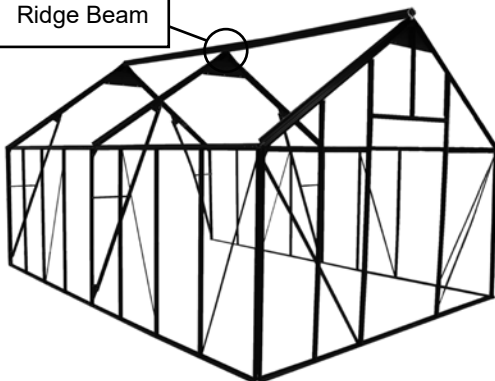

3. With the end wall and ridge beam in place, continue by installing the roof rafters as described in the **ROOF FRAME INSTALLATION** procedure.

103967 GREENHOUSE

After installing the two (2) sections of sidewall framing, complete or repeat the following procedures.

ATTENTION: This procedure requires *parts from Box 9-8 for the 103967 greenhouse.*

1. Take the 1650-4 ridge beam from Box 9-3, close the box, and set the ridge beam on the box for later use.
2. Open Box 9-8. *Do not mix the parts from separate boxes.*
3. Using the previous "**Assemble Main Frame Mid Rafter**" procedure, select the required parts, and *assemble the final mid rafter.*
4. Attach the mid rafter to the main frame as described in the "**Attach the Assembled Mid Rafter**" procedure.

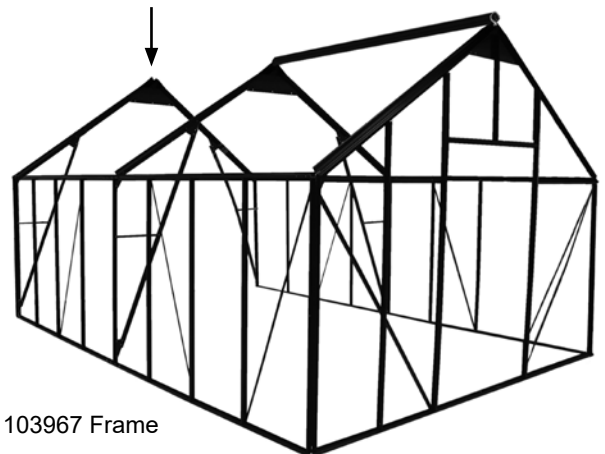

5. Take the 1650-4 ridge beam (Step 1 above) and refer to the "**Install Ridge Beam**" procedure to attach the 16506 brackets to the beam and to attach the beam to the installed ridge beam and to the main frame.

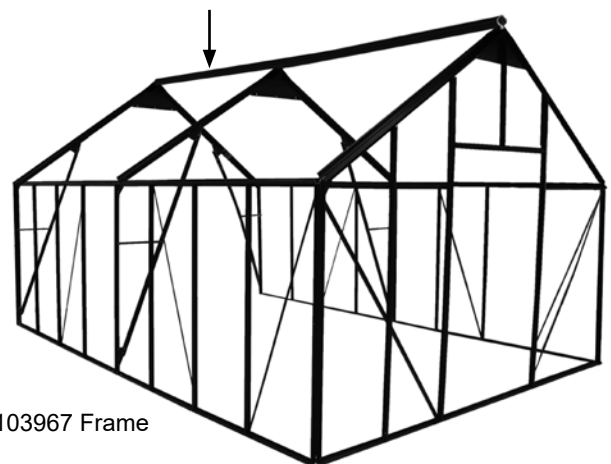

NOTE: The 16506 brackets and hex-head bolts for this step are *found in Box 9-8.* Refer to the diagram (Step 2) in the left column to attach the separate ridge beams.

GROWSPAN™ ESTATE PRO I GREENHOUSES

103967 ASSEMBLY (CONTINUED)

- Using the previous **"Assemble Next 2 Sections of Sidewall Frame"** instructions, construct another pair of sidewall frames with *parts from Box 9-8*.
- Attach the assembled sidewall frames to the main frame. Use the **"Attach Sidewall Frames to Main Frame"** procedure.
- Once the final sections of sidewall frames are attached to the assembled main frame, attach the final end wall frame to the main frame.

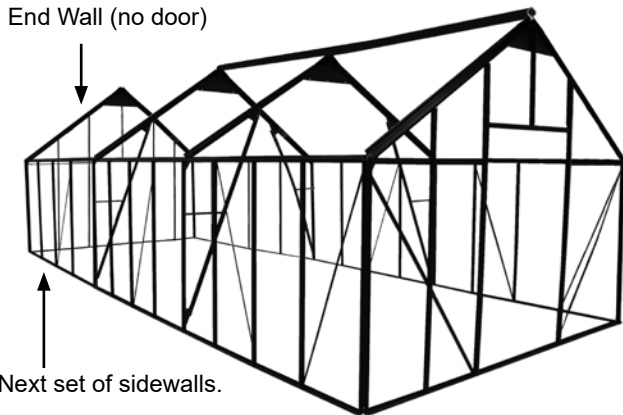

NOTE: Consult the previous **"Assemble the First Greenhouse Section"** procedure if needed to view the details for attaching a sidewall frame to an end wall frame.

- Attach the final section of 1650-4 ridge beam (from Box 9-8) to the previous ridge beam and to the frame.

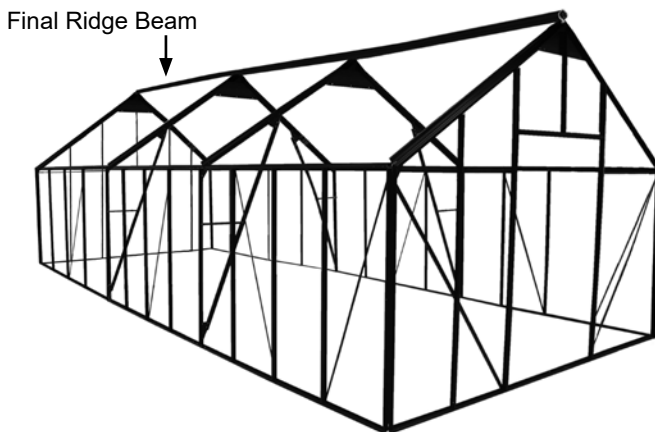

- With the final ridge beam secured to the main frame, continue with the **ROOF FRAME INSTALLATION** procedure.

ROOF FRAME INSTALLATION

The roof rafters are installed with the bolt tracks to the inside of the greenhouse.

ATTENTION: Consult the Roof Frame diagrams near the end of this instruction packet for a quick overview of the roof frame assembly for your greenhouse.

- Select the first set of rafters (1651), diagonal braces (1695), and bolts and nuts from the following box:

Greenhouse Sku Number	Work from this open box:
104564	C/No. 7-2
103967	C/No. 9-2

- Consult the Roof Frame diagram near the back of these instructions to determine the position of the parts and where to install additional bolts.
- Working *from the door end of the frame*, move to the first rafter position on one side of the roof, slide the required number of bolts into the bolt track of the 1651 rafter, and attach the rafter to the gutter rail and to the ridge beam.

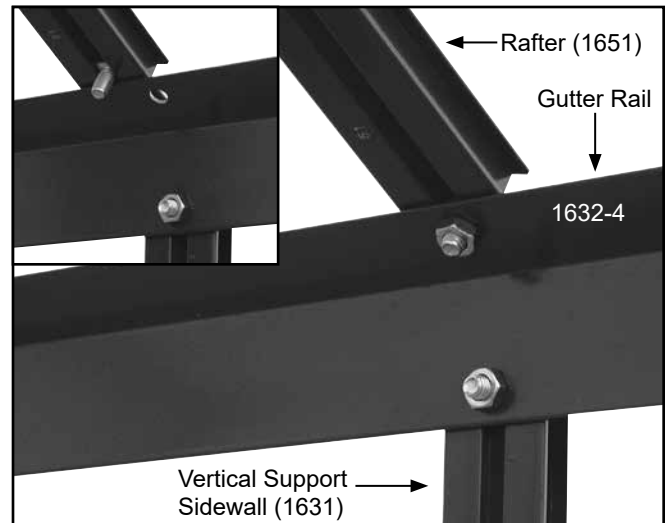

View is from the inside of the greenhouse.

NOTE: Verify that the correct number of additional bolts for vents and diagonal struts has been slid into the bolt track of each 1651 rafter that is installed. Consult the Roof Frame diagram for details.

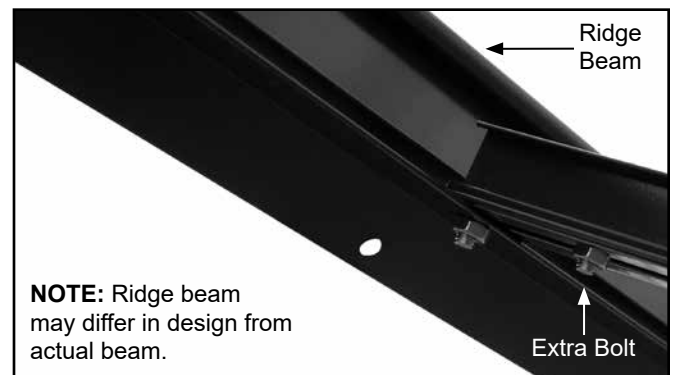

NOTE: Ridge beam may differ in design from actual beam.

ROOF FRAME INSTALLATION (CONTINUED)

4. Tighten the mounting bolts at the gutter rail and ridge beam positions at this time.

NOTE: The additional bolts slid into the track for each rafter are used when the diagonal braces and vents are installed.

5. Repeat these steps to install the remaining 1651 rafters from the box identified in Step 1.
6. Follow the Roof Frame diagram near the back of this document to determine the position of each diagonal brace and install the braces (1695).

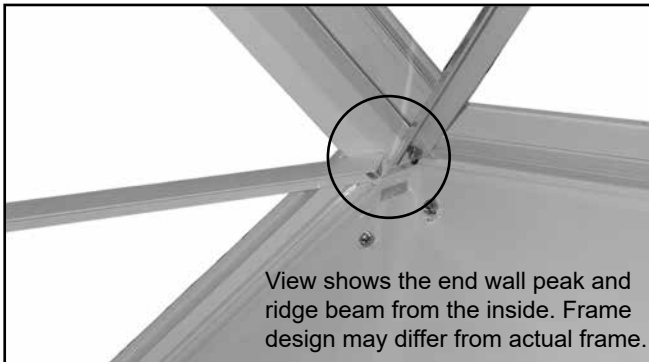
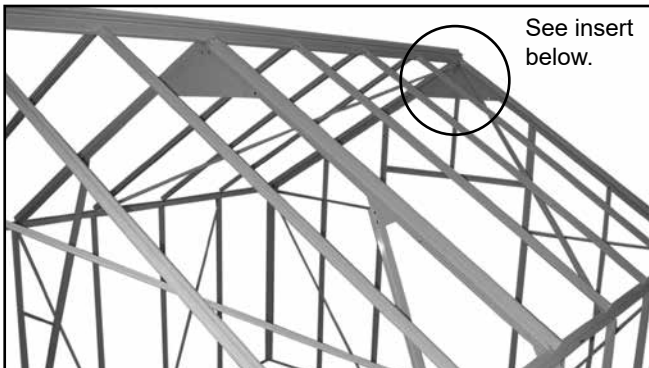

ATTENTION: The nuts used to secure the ridge beam and gutter rail are removed and reattached to secure the ends of each diagonal brace at those locations shown on the Roof Frame diagram.

7. Where a diagonal brace crosses a rafter, slide one (1) of the extra bolts on the rafter to the diagonal and place it in the pre-drilled hole on the diagonal.

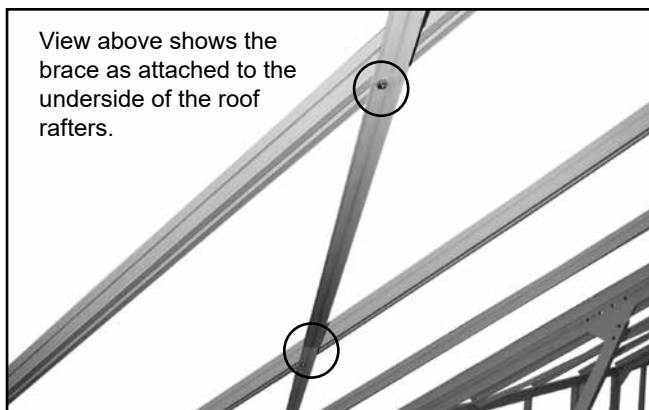

8. Add a nut to the bolt. Once the diagonal is secured to each rafter, tighten the nuts.
9. After all rafters and diagonals are installed from the first box (Step 1), move to the next box (shown below), and repeat the steps to install the rafters (1651) and diagonal braces (1695) from that box.

Greenhouse Sku Number	Work from this open box:
104564	C/No. 7-3
103967	C/No. 9-3

NOTE: As rafters are added, continue working from the door end toward the non-door end wall of the assembled frame.

10. After all rafters and diagonals are installed from the second box (Step 9), complete the following step for the selected greenhouse:

For the 104564 greenhouse, continue with the "Roof Vent Assembly and Installation" instructions.

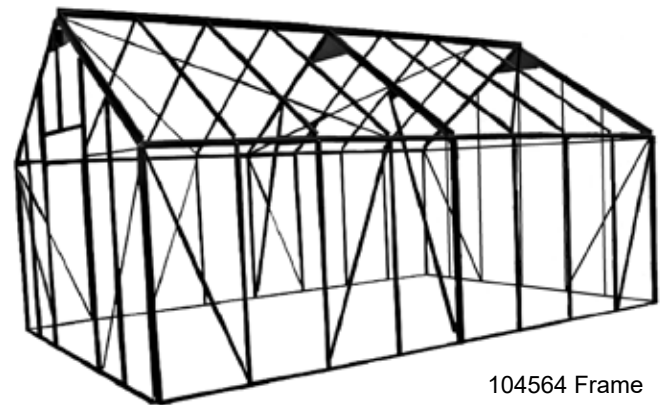

104564 Frame

For the 103967 greenhouse, continue with the next step.

11. Remove the 1651 rafters and the 1695 braces from Box 9-8 (103967 only) and repeat the steps to attach these to the assembled frame.

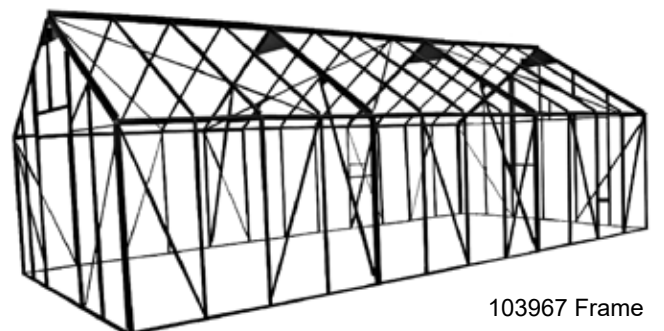

103967 Frame

12. After installing all rafters and diagonal braces, continue with the "Roof Vent Assembly and Installation" instructions.

GROWSPAN™ ESTATE PRO I GREENHOUSES

ROOF VENT ASSEMBLY AND INSTALLATION

All vent frame parts are *packaged in two (2) separate poly bags for each roof section*. Consult the table below for box numbers for your greenhouse:

Greenhouse Sku Number	Vent frames in boxes:
104564	C/No. 7-2 and 7-3
103967	C/No. 9-2, 9-3, and 9-8

NOTE: All photos show the vent frame *with the inside surface facing up*. When installed, the frame surface shown in the photos is *seen from inside the greenhouse*.

All vent frames are identical and assembled the same.

1. Locate and open one (1) vent frame package.

NOTE: To avoid mixing parts, open one frame only.

2. Arrange the parts as shown. See the *Vent Frame diagram for part identification if needed and complete the assembly*.



3. Using the small Phillips head bolts and nuts, attach the bottom rail to the side rails. *Do not tighten these at this time*.
4. Next, attach the top hinge rail to the side rails using the Phillips head bolts.
5. Using a carpenter's square (or other means), verify that the assembled vent frame is square and tighten the bolts.



6. Remove the bolt from the pre-assembled vent support arm (1674) and attach the mounting bracket to the frame (1672) and reattach the 1674 support arm.

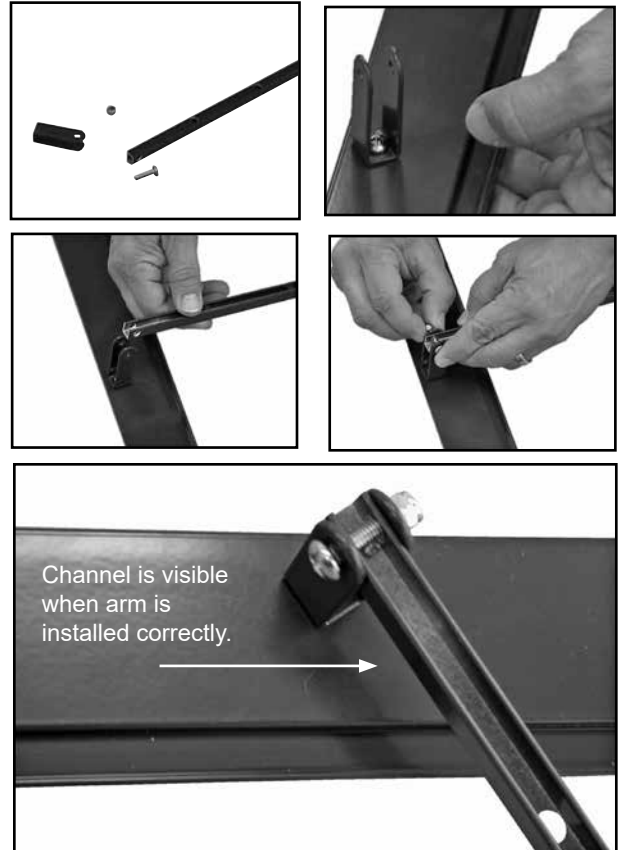

NOTE: Attach the mounting bracket to the frame using a small bolt and a self-locking nut. The bracket and arm must be allowed to swivel on the frame rail. When the arm is properly installed, the channel of the support arm will be visible from inside the greenhouse when the arm is properly installed.

7. Repeat the above steps for the remaining support arm.
8. Once the vent frame is assembled, locate the two 1675 cross members for the vent frame.



Photo shows the notched edge of the 1675 cross member, which is installed toward the ridge beam (or peak) of the greenhouse roof. The selected hole in the channel of the 1674 support arm is placed over the center pin of the notch to hold the vent open.

**ASSEMBLE AND INSTALL THE ROOF VENTS
(CONTINUED)**

- Install the two (2) 1675 cross members between the three rafters where the vent frame will be installed.

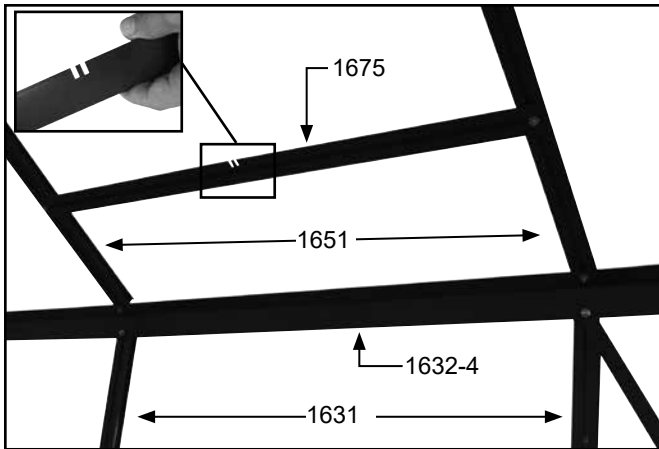

NOTE: View shows the frame as seen when standing on the inside. Only one (1) 1675 frame member is shown in the above photo.

- Using the bolts added to the bolt tracks of the rafters, attach the cross members (dashed line below) between the three (3) rafters. Bolts should remain snug. *Do not fully tighten the bolts at this time.*

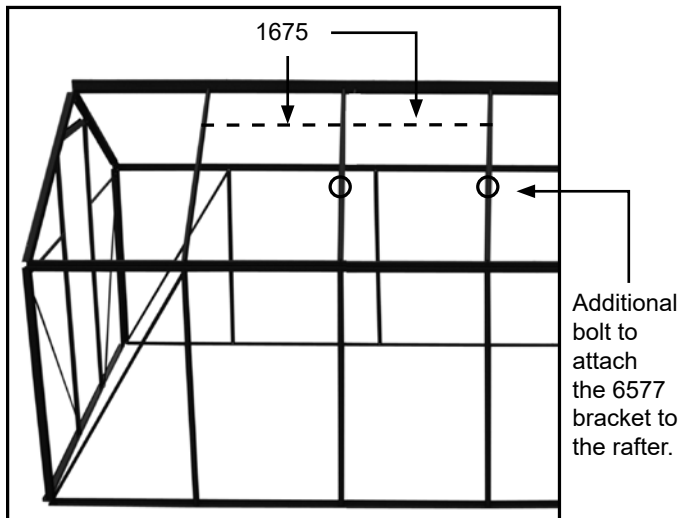

NOTE: Picture shows where to position the 1675 cross member. *The frame shown may differ from the actual greenhouse.* Consult the diagrams near the back of these instructions for additional details.

The last additional bolt in the track of the second and third rafter must remain between the bolt used to secure the 1675 cross member and the bolt used to secure the 1651 rafter to the 1632-4 gutter rail.

See the circles in the above photo. These bolts are used to attach the 6577 brackets to the rafters. The 6577 brackets secures the vent support arm when the vent is closed. *Add bolts if needed.*

Photo below shows one end of the 1675 cross member where it is attached to the rafter. The bolt is on the underside of the rafter (which is to the inside of the greenhouse).

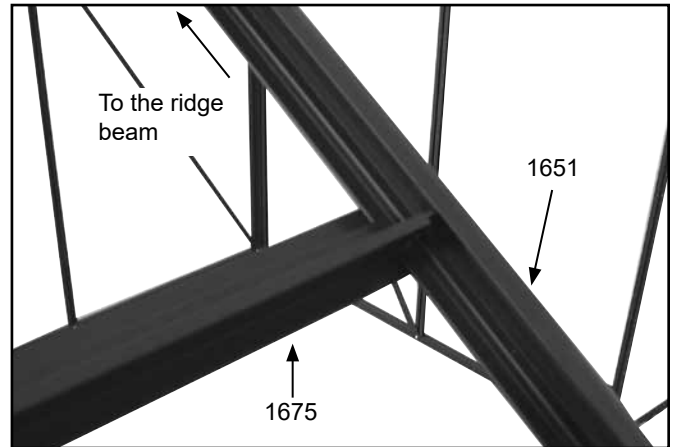

View shows the 1675 cross member *from the outside.*

- After attaching the 1675 cross members, take the assembled vent frame and insert one end of the 1670 frame member into the C-channel of the ridge beam. See the photos below and vent frame diagram near the back these instructions for details.

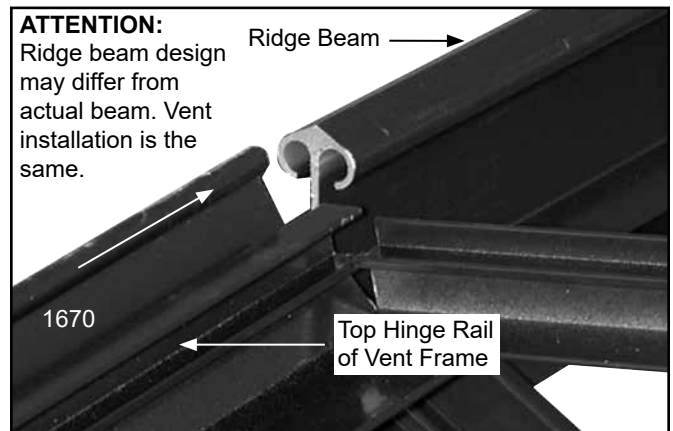

Slide the 1670 frame member into the channel of the ridge beam. The side of the vent frame that was facing up during its assembly should now be facing to the inside of the greenhouse frame.

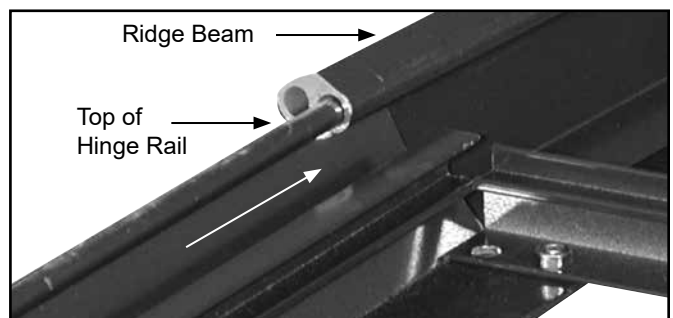

ATTENTION: You must flip the assembled vent frame over so that the rounded edge of the top hinge rail can be inserted into the channel of the ridge beam.

GROWSPAN™ ESTATE PRO I GREENHOUSES

ASSEMBLE AND INSTALL THE ROOF VENTS (CONTINUED)

- Continue to slide the vent frame into the channel until the vent frame is aligned between the two rafters where the 1675 cross members were installed.
- Once aligned, allow the vent frame to rest in the closed position on the rafters.
- Loosen the bolts (if needed) and slide the 1675 cross members up until it touches the bottom rail of the assembled vent frame. See the photo below.

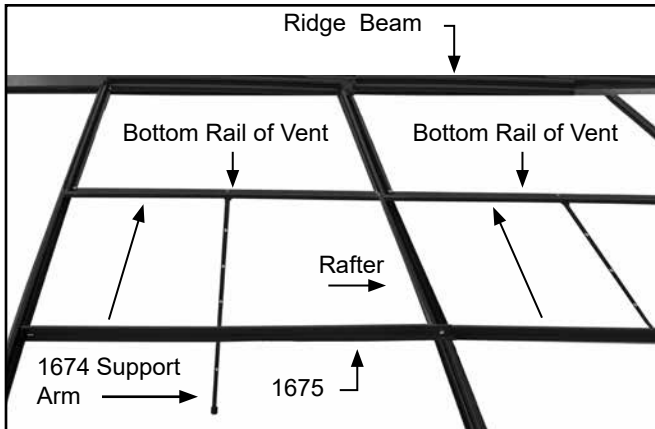

View is from the outside of the greenhouse. The double vents will span two (2) rafter sections.

NOTE: To prevent binding, *do not* seat the 1675 cross members tightly against the bottom rail of the vent frame.

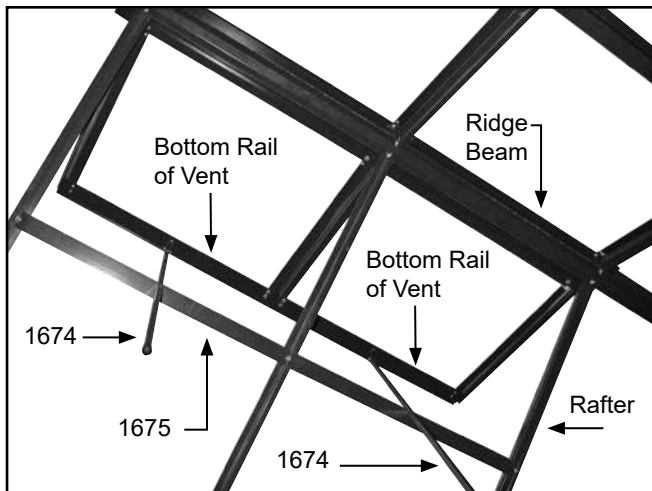

View is from the inside of the greenhouse looking up at the installed vent frame and the 1675 cross members.

- With the cross member in position, test the operation of the vent frame and tighten the bolts to secure the 1675 cross members.

- Working from *inside the greenhouse*, close the vent and swivel the vent support arm down and toward the second rafter.

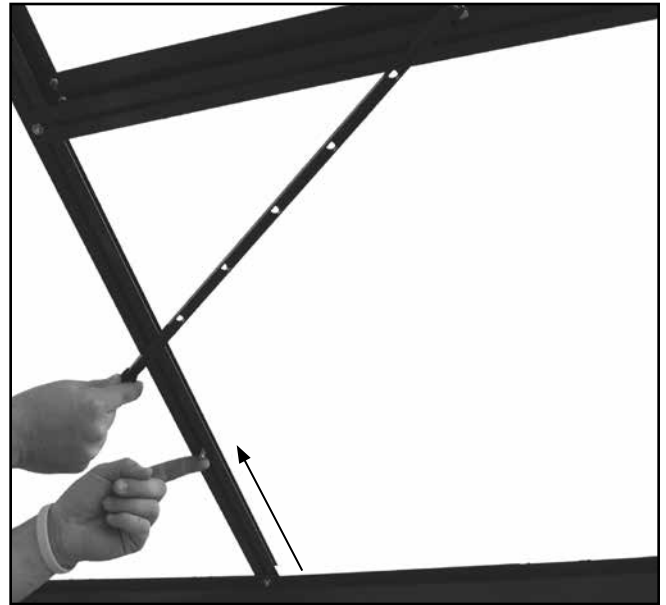

NOTE: This will be the rafter where the remaining "extra" bolt is located. If no bolt is present, loosen the rafter at the gutter rail, *slide* a bolt into the bolt track, and retighten the rafter mounting bolt.

- Slide the remaining bolt up to the support arm as shown and attach the Z-bracket as shown below.

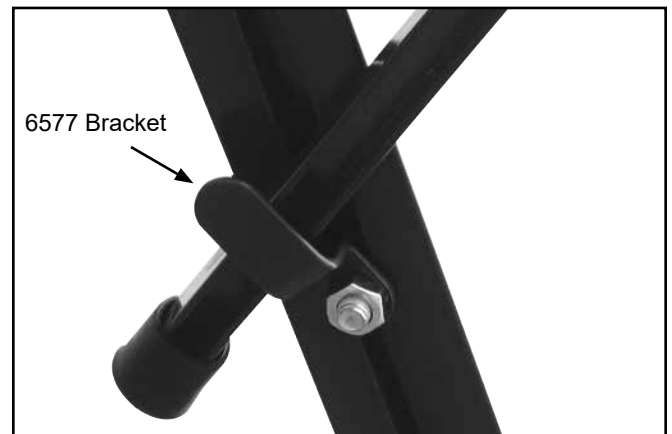

- With the 6577 bracket attached, lift the support arm out of the bracket and remove the vent frame from the greenhouse to install the polycarbonate panel.

NOTE: The polycarbonate panels for the vents can be installed with the vent frame attached to the greenhouse roof if desired. This procedure installs the polycarbonate panels with the assembled roof vents removed for easier accessibility.

- Repeat the steps to assemble and install the remaining vent frame or frames.
- After all vents are assembled, installed, fitted in the frame, and removed, install the vent panels.

INSTALL THE POLYCARBONATE VENT PANELS

The steps below describe attaching the polycarbonate vent panels to the assembled vent frames. The panels are lettered for identification. Consult the panel diagrams and the diagrams on the outside of each shipped box to locate and identify parts. *See Page 39 for additional information.*

The parts needed to complete the vent frame assembly include the following:

- Polycarbonate Panels: Letter X
- U602 U-profile and silicone

Greenhouse Sku Number	Panels/U602 in boxes:
104564	C/No. 7-6 and 7-7
103967	C/No. 9-6, 9-7, and 9-9

NOTE: The plastic U-strips are precut and are as long as the polycarbonate panel is wide. *You do not have to cut any plastic molding.* If it appears as though the plastic profile is the incorrect length, verify that you have selected the correct panel and profile. *Consult the panel diagrams near the back of these instructions for details.*

Do not allow panels to remain in direct sunlight with the protective film intact.

Complete these steps:

ATTENTION: Install the polycarbonate panels with the UV-protected side to the *outside of the greenhouse*. If you remove the protective film before installing the panels, mark the panel in a lower corner to identify the UV-protected side.

1. Locate the first X panel and the plastic U-strips for that panel.

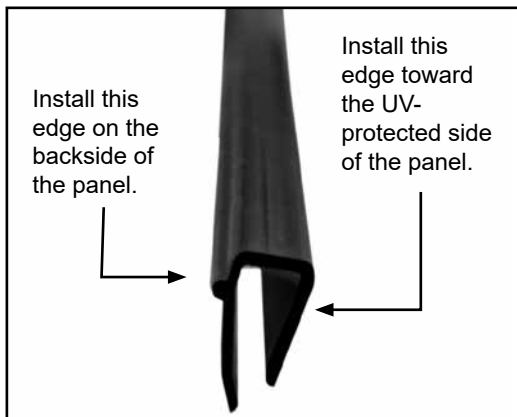

Plastic U-Profile

2. Carefully peel the protective film away *from the edge* on both sides of the panel if needed.

To prevent scratching the panel, *do not* completely remove the protective film until the plastic U-strips are installed.

3. Take one U-strip and install it on the top edge of the polycarbonate panel.

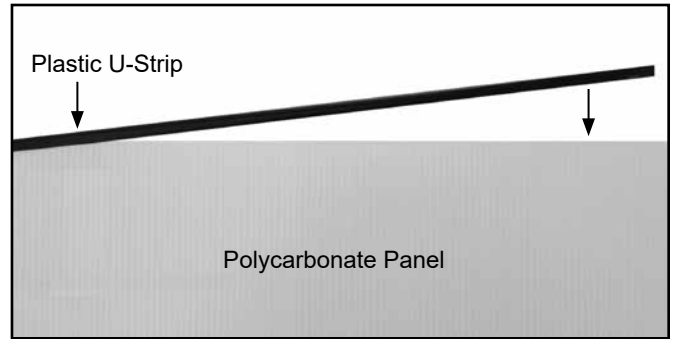

NOTE: The top and bottom edges of each panel show the hollow cells inside the panel. When installing the plastic molding, rest the panel on cardboard or other material to protect the edges and surface of the panel.

4. Take the remaining strip and attach it to the bottom edge of the panel.

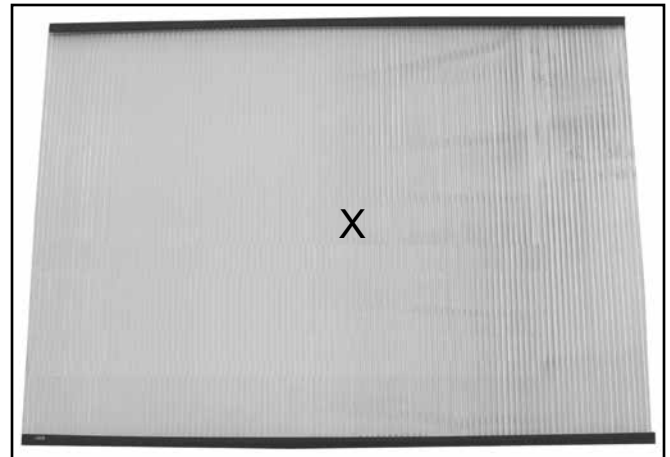
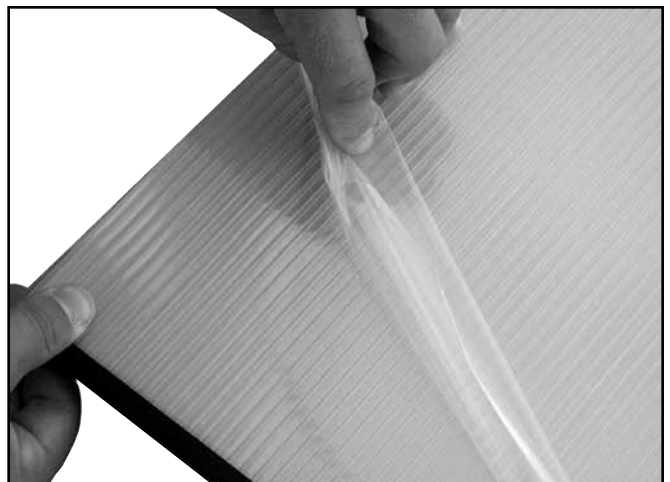

Photo shows one panel to cover one side of the vent frame.

5. With both U-strips installed on the panel, remove the remainder of the protective film.



6. Mark the UV-protected side with a piece of tape or a marker and *set the panel to the side.*

GROWSPAN™ ESTATE PRO I GREENHOUSES

INSTALL THE POLYCARBONATE VENT PANELS (CONTINUED)

7. Move to the assembled vent frame, open a tube of silicone, and apply a small bead along the sides of the vent frame *on the outside surface*.

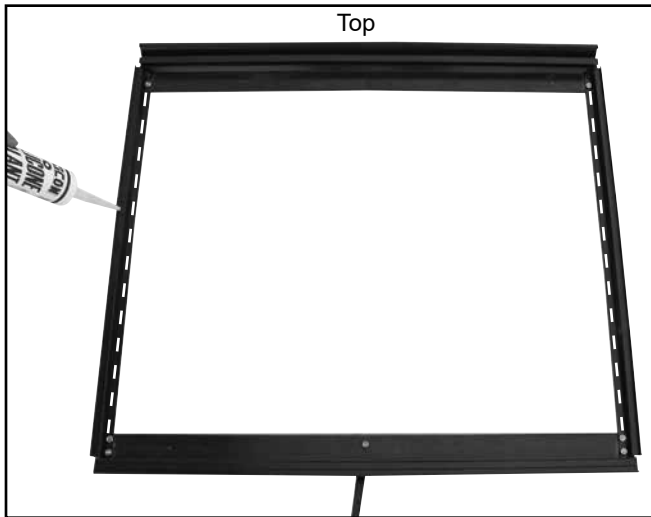

Smaller vent shown for clarity.

ATTENTION: The vent frame is positioned with the *outside facing up*. The dashed lines show where to apply the silicone.

8. With the silicone applied, take the prepared panel and set it in the vent frame *with the UV-protected side facing up to the outside*.

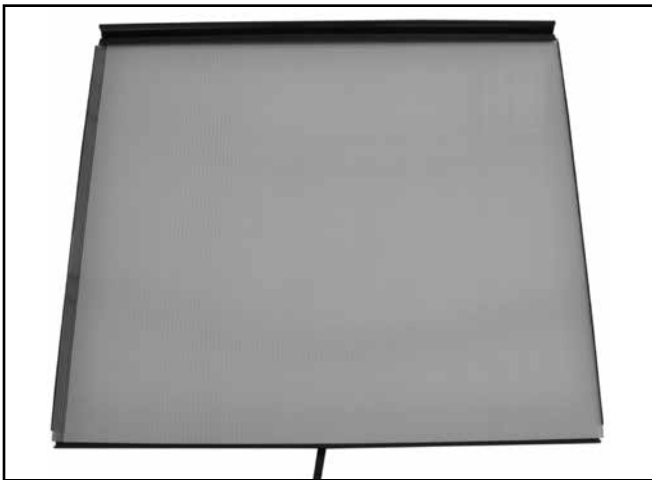

Photo shows the polycarbonate panel as installed in the vent frame. (In the photo, the protective film was not removed to better show the panel in the frame.)

9. Repeat the above steps for all remaining vent panels.
10. After the silicone sets, slide the vent frames back into to the ridge beam (if they were removed to install the polycarbonate panels).
11. Read the anchoring instructions and information that follows and then continue with the door assembly procedures *after you anchor the greenhouse frame*.

ANCHORING INSTRUCTIONS

To prevent serious personal injury and property damage, you must anchor the assembled greenhouse frame before continuing.

Failing to properly anchor the greenhouse frame will void all warranties.

If you did not purchase one of our recommended anchoring systems and want to now, contact your sales representative at 1-800-245-9881.

Consult a professional and qualified contractor for anchoring suggestions if you have not decided how to anchor the greenhouse.

Read the anchoring information that follows and anchor the assembled greenhouse frame.

ANCHOR THE GREENHOUSE

The site and whether the optional base is used determine the recommended anchoring methods for the greenhouse.

⚠ WARNING: You must anchor the greenhouse (and the base if used) to the site and *before* installing the panels. Failing to do so may result in property damage and personal injury.

The information below identifies the recommended anchoring methods for your greenhouse. There are four basic scenarios when anchoring the greenhouse. Choose the one that matches your particular application.

If none of the following anchoring suggestions is applicable to your greenhouse, *you must seek the advice of a professional and qualified contractor to anchor your greenhouse to the site*.

ATTENTION: Since different applications require different anchoring methods, contact your sales representative for the parts required to anchor the greenhouse and frame. Contact Customer Service at 1-800-245-9881 to purchase additional anchoring parts.

Continue with the following anchoring information on the following page.

ATTENTION: TO AVOID TWISTING OFF OR DAMAGING THE FASTENERS, DO NOT OVERTIGHTEN.

FOR YOUR CONVENIENCE, ADDITIONAL FASTENERS CAN BE FOUND IN THE "EXTRA PARTS" BAG OR BOX. REFER TO THE BILL OF MATERIALS FOR A LIST OF THE FASTENERS CONTAINED IN THAT BAG OR BOX.

ANCHOR THE GREENHOUSE (CONTINUED)

SCENARIO #1: Base Frame On Soil (or Gravel) Site

Ground posts are used to anchor the optional base to the site before the assembled greenhouse frame is set on the base.

1. After squaring the base and driving the support posts into the ground (see the Base Assembly instructions presented earlier in this packet), select the *ground posts for the anchoring system*.
2. Determine whether you want the ground posts on the inside or outside of the base assembly.

NOTE: Ground posts are driven into the site near each corner of the assembled frame. Ground posts *must be ordered*. They are not included with the greenhouse.

3. Using the following diagrams, drive each ground post into the site flush with the top of the base channel.

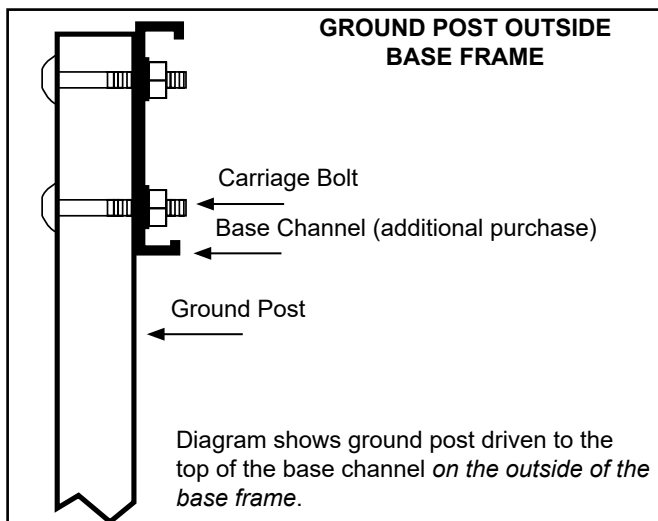

NOTE: When the ground post is *on the inside of the base*, use as spacer placed between the base channel and ground post to prevent crushing the channel when the bolts are tightened as shown below.

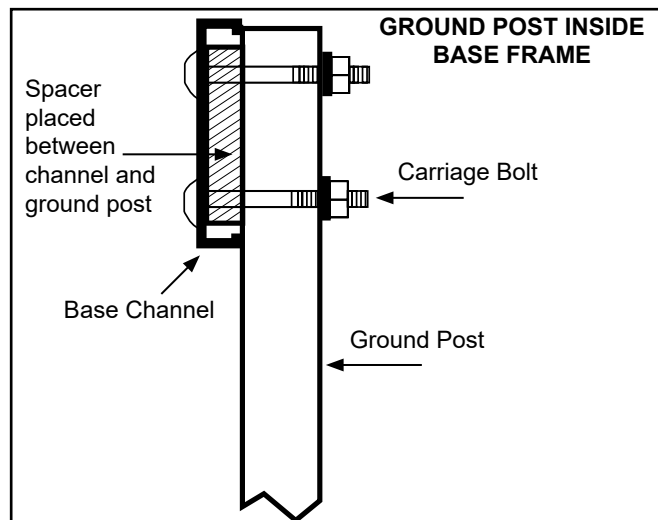

4. With the ground posts driven into place, use the holes in the ground post as a guide, drill a hole through the base channel, and attach the base to each ground post as *shown in the previous diagrams*.
5. With the base secured, set the assembled greenhouse frame on the anchored base.
6. Attach the greenhouse frame to the anchored base using self-tapping screws driven through the base rail and into the base channel.

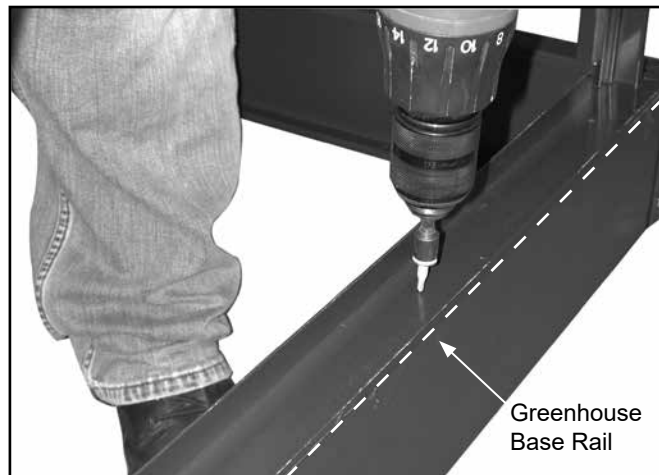

Photo is used for illustration purposes only. The dashed line shows the lip of the base rail of the greenhouse.

NOTE: Count the Tek screws sent with the base kit and install screws evenly around the perimeter of the frame between each vertical support.

7. Continue with the greenhouse assembly procedures as instructed.

EXTRA PARTS PROVIDED FOR GREENHOUSE

ATTENTION: TO AVOID TWISTING OFF OR DAMAGING THE FASTENERS, DO NOT OVERTIGHTEN.

FOR YOUR CONVENIENCE, ADDITIONAL FASTENERS AND PLASTIC MOLDING CAN BE FOUND IN THE "EXTRA PARTS" BAG OR BOX.

REFER TO THE BILL OF MATERIALS FOR A LIST OF THE FASTENERS AND MOLDING CONTAINED IN THAT BAG OR BOX.

The plastic profile can be trimmed to the required length if a piece is misplaced or damaged during installation.

IMPORTANT: Consult the "extra parts" for items you need before contacting customer service to request a replacement for damaged or missing parts or fasteners.

GROWSPAN™ ESTATE PRO I GREENHOUSES

ANCHOR THE GREENHOUSE (CONTINUED)

SCENARIO #2: Base Frame On Concrete (Slab or Patio)

Concrete anchor bolts are used to secure the base to the concrete slab before the assembled greenhouse frame is set on the base.

1. After the base is assembled and the frame support posts are cut to the proper length (see the Base Frame Assembly instructions) position the base on the site with the *bottom edge of the base facing up*.
2. Using a drill bit the same diameter as the concrete anchor bolts, drill holes through the edge of the base channel.

NOTE: Use 24" spacing when drilling the holes. You must use concrete wedge anchors for this application.

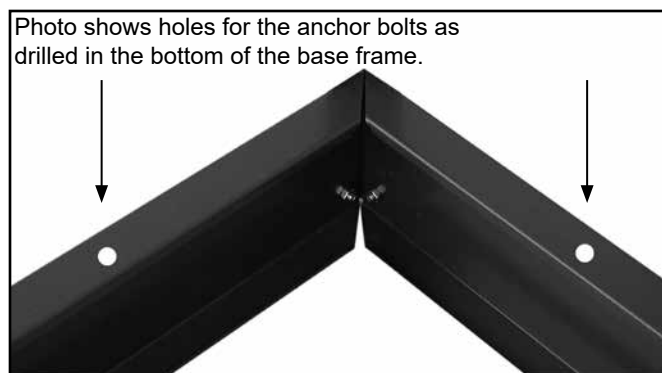

3. After all holes are drilled, flip the base frame and reposition it on the site.
4. Square the frame as previously described in the Base Assembly procedure.
5. Using the holes drilled in the base channel (Step 2) as guides, take a marker, and mark the hole location on the concrete.
6. Remove the frame, drill the holes in the concrete using the proper bit, and install the anchor bolts in the concrete.
7. Reposition the base frame over the anchor bolts in the concrete and anchor the base to the site using the anchor bolts.
8. Anchor the assembled greenhouse frame to the base as shown in *Step 6 of the previous anchoring instructions* and continue with the greenhouse assembly procedures as instructed.

SCENARIO #3: No Base Frame: Greenhouse Is On Concrete Slab (or Patio)

If the greenhouse frame is assembled and no base frame is used, the greenhouse is anchored to the concrete using anchor bolts as previously described.

1. Position the assembled greenhouse on the site and *square the greenhouse* using the technique described in the Base Assembly instructions presented earlier in this packet.
2. After squaring the assembled greenhouse frame, drill a hole through the base rail of the sidewall of the greenhouse frame and install a concrete anchor bolt.

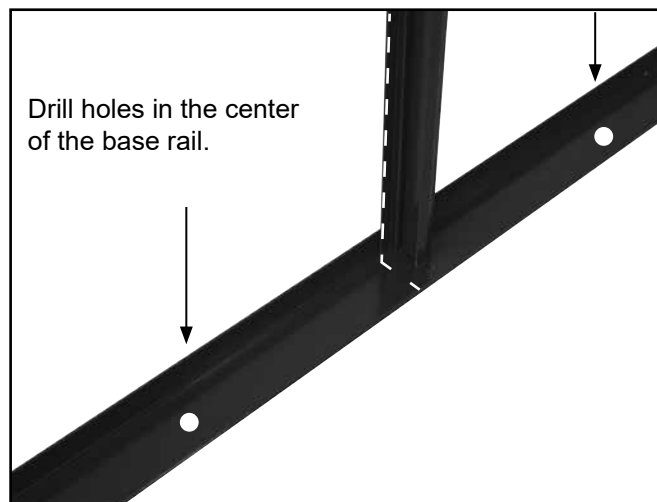

NOTE: Holes for the anchor bolts are drilled through the base rail and into the concrete between each of the vertical supports. Photo above shows the greenhouse frame as seen from the outside of the greenhouse.

3. Move to the opposite side of the frame and repeat the previous step to anchor the frame to the site.
4. Continue by repeating the above steps until the greenhouse frame is anchored.
5. After anchoring the greenhouse frame, continue with the greenhouse assembly instructions.

SCENARIO #4: No Base Frame: Greenhouse Is On Soil (or Gravel)

To anchor the assembled greenhouse frame to a non-concrete site without the optional base frame, *you must use a treated-wood base frame to set the greenhouse on.*

Ground posts are then driven into the ground on either the inside or outside of the treated-wood base frame. The wood frame is anchored to the ground posts using lag screws inserted through the ground post holes and screwed into the wood.

After securing the treated-wood frame to the ground posts, the assembled greenhouse frame is placed on the wood base, squared, and anchored to the wood base using lag screws inserted through pre-drilled holes in the base rail of the greenhouse frame and screwed into the wood. Use the diagrams below to anchor the greenhouse to a non-concrete site when the optional base frame is not used.

Diagram shows lag screws installed through the ground post and into the 4" x 4" treated wood base frame. *The dashed line shows where to install the lag screw when a 2" x 4" or 2" x 6" treated-wood frame is used.*

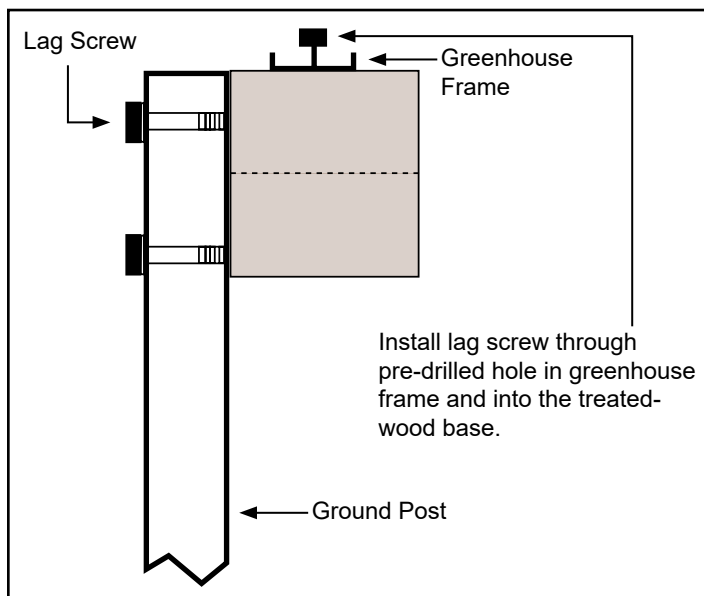

Diagram may not be to scale.

NOTE: Only the top hole in the ground post is used when a 2" x 4" or 2" x 6" treated-wood base is used.

In all instances for the wood base, the ground posts are driven flush to the top of the wood base as shown.

After anchoring the treated-wood frame to the site and the greenhouse frame to the wood frame, continue with the greenhouse assembly instructions that follow.

ASSEMBLE AND INSTALL THE DOORS

After anchoring the greenhouse frame, assemble the door.

NOTE: The following photos may show a door of a different color or slightly different design. The assembly and installation procedures are the same for all similar doors and applications. Consult the door diagram near the back of these instructions for part details.

Greenhouse Sku Number	Door frames in box:
104564	C/No. 7-4
103967	C/No. 9-4

Complete these steps to assemble and attach the door to the greenhouse frame.

1. Locate all door parts and assemble them on a clean surface. (Place and assemble the parts on cardboard to protect the finish.)

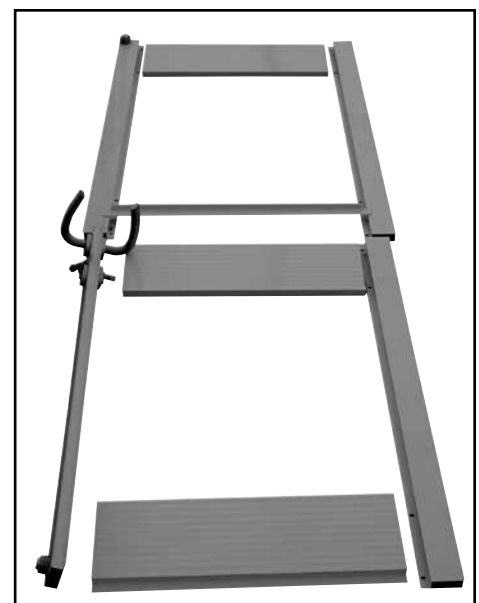
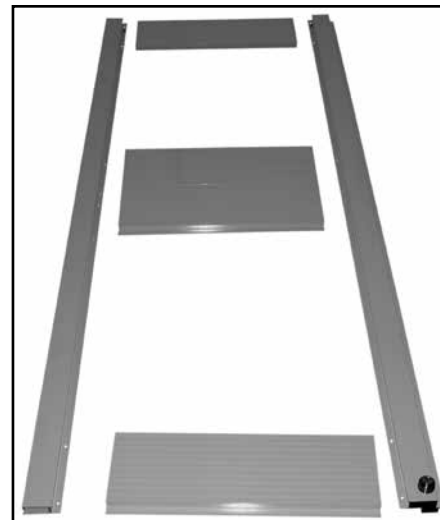

See the Door Frame Diagram for parts identification.

GROWSPAN™ ESTATE PRO I GREENHOUSES

ASSEMBLE AND INSTALL THE DOORS (CONTINUED)

- Slide the bolts into the bolt track of the door cross members and attach the cross members to the vertical side members of each door frame.

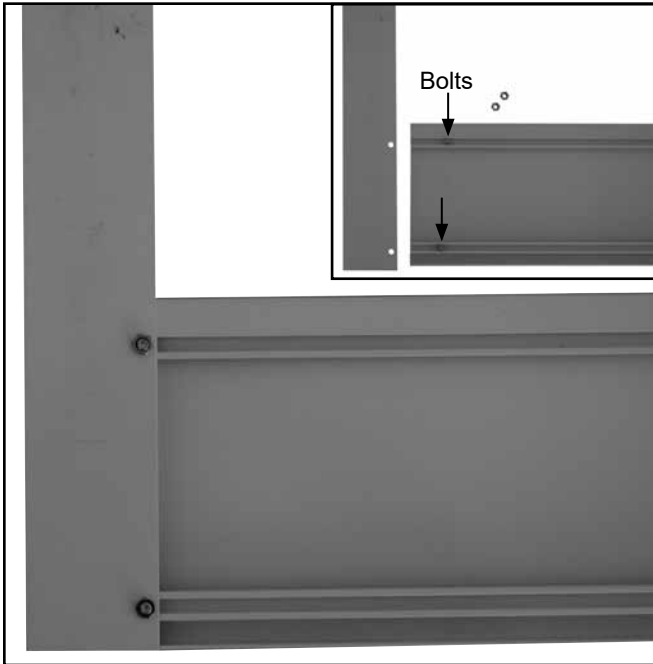

NOTE: Verify that the side members are seated tightly to the cross member to maintain door width.

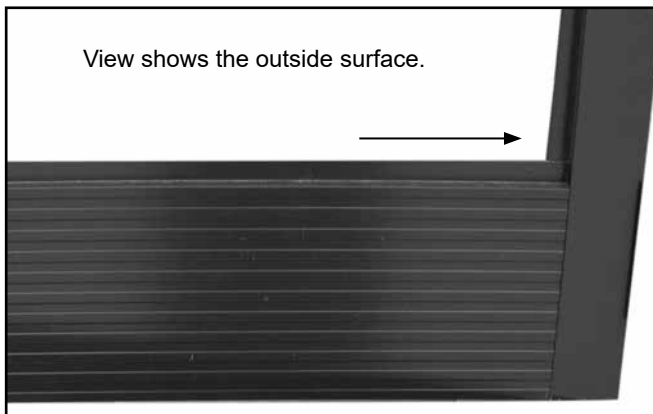

- Continue connecting the door components until all door frames are assembled.
- Locate the door stop frame member (16640) and *attach it to the inside top of the lower door frame.* (Screws to mount this are usually included inside the plastic that the door stop is packaged in.)

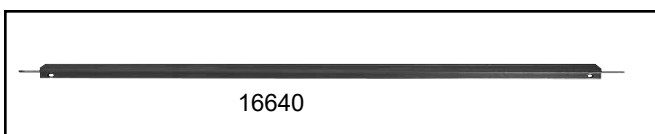

NOTE: When attached correctly, the 16640 door stop prevents the upper door from swinging into the greenhouse.

The dashed line (below) shows the location of the 16640 frame member shown in the photo below.



- Secure the assembled door frame to the greenhouse end wall frame.

This procedure describes attaching the assembled doors to the end wall framing and then installing the polycarbonate panels for the door.

If you want to install the panels before the doors are hung, skip to that section and install the panels. Then return to this step to attach the doors to the end wall frame.



Secure hinges to end wall frame.

ATTENTION: Loosen the header of the end wall and move it up if the opening is too small for the door.

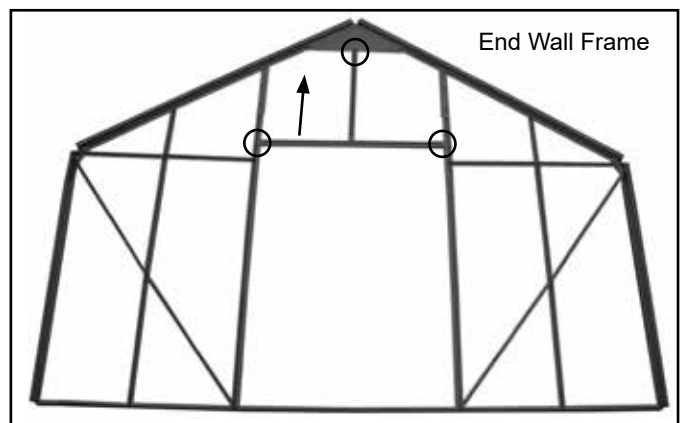

To adjust the header, loosen the bolts only in the locations identified by the circles in the above diagram.

ASSEMBLE AND INSTALL THE DOORS (CONTINUED)

- Attach the latch to the inside of the upper door as shown below. *Some latches come pre-installed.*

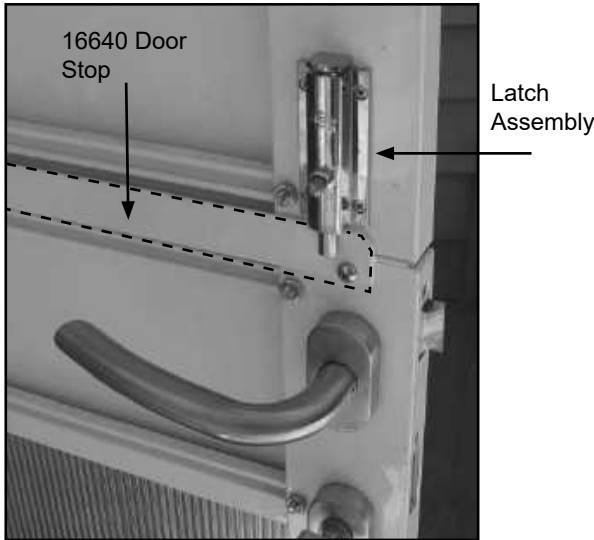

NOTE: If your greenhouse includes a single door, assemble and attach that door frame now and continue with the next steps.

- Once the doors are assembled and installed, return to the header of the end wall frame and adjust it as needed. *See diagram in Step 5 if needed.*

NOTE: After adjusting the header, test the operation of the doors to verify that enough clearance is present to allow the doors to open and close smoothly.

- Tighten all header bolts and test the operation of all latches. Adjust header if needed and retighten.
- Prepare and install the polycarbonate door panels.

INSTALL THE POLYCARBONATE DOOR PANELS

The steps to prepare and install the polycarbonate panels for the doors are similar to those described in the vent panel installation procedure. The door panels are lettered for identification.

NOTE: The protective film has not been removed in the following photos. *You must remove the film as instructed during the assembly process.*

The parts needed to complete the door frame assembly include:

- Polycarbonate Panels: Y
- U485 U-profile and silicone

Greenhouse Sku Number	Panels/U485 in box:
104564	C/No. 7-5
103967	C/No. 9-5

NOTE: Verify that you have selected the correct panels and U-profile. *You do not have to cut any plastic profile. Consult the panel diagrams near the back of these instructions for additional information.*

Complete these steps:

ATTENTION: Install the polycarbonate panels with the UV-protected side to the *outside of the greenhouse*. If you remove the protective film before installing the panels, mark the panel in a lower corner to identify the UV-protected surface. See page 39 for additional polycarbonate installation information.

- Locate the first Y panel and two lengths of the U485 profile for that panel.
- Carefully peel the protective film away from the edge on both sides of the panel.

NOTE: To protect the panel, *do not* completely remove the protective film until the U-profile strips are installed.

- Take one U485 profile section and install it on the top edge of the polycarbonate panel.

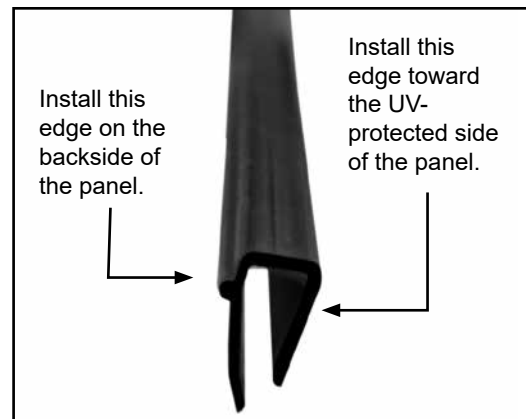

Plastic U-Profile

NOTE: The top and bottom edges of each panel show the hollow cells inside the panel. When installing the plastic profile, rest the panel on cardboard or other material to protect the edges and surface of the panel.

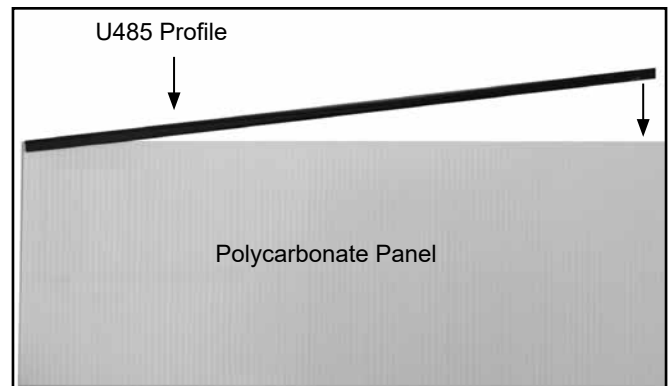

- Take the remaining U-strip and attach it to the bottom edge of the panel.

GROWSPAN™ ESTATE PRO I GREENHOUSES

INSTALL THE POLYCARBONATE DOOR PANELS (CONTINUED)

5. With the U-profile installed on the panel, remove the protective film (if this has not been completed).

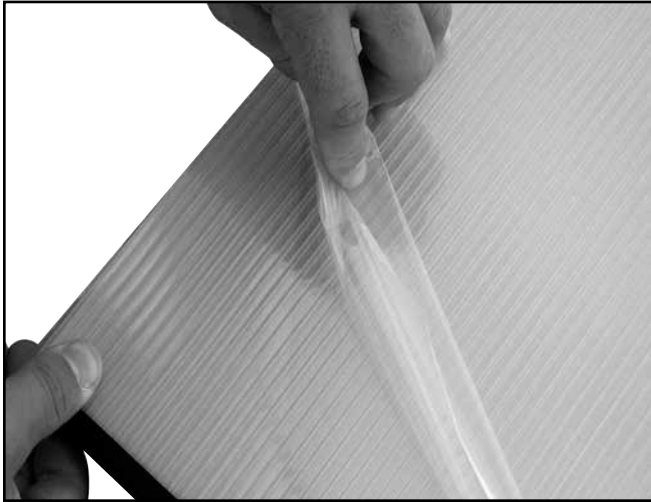

6. Mark the UV-protected side with a piece of tape or a marker and remember that it is installed to the outside.
7. Close the doors to prevent them from moving and apply a bead of silicone along the panel frame edge of the door. See the photo below.

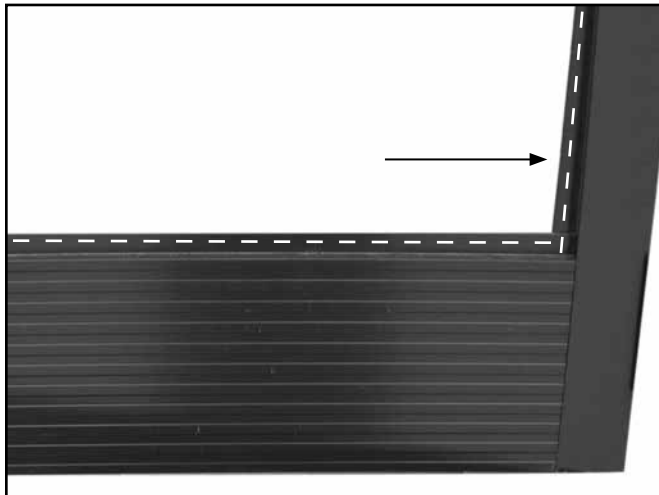

NOTE: Photo shows the lower-right corner of one door frame. Dashed line shows where to apply silicone.

8. Verify that the *UV-protected surface is to the outside* and place a prepared panel into the door opening.
9. Repeat the steps to attach the remaining polycarbonate panels to the remaining door frames.
10. After the silicone sets to secure the panels, attach the doors to the end wall frame (if needed) and continue with the installation of the gutter ends.

INSTALL THE GUTTER RAIL ENDS

Before installing the remaining polycarbonate panels, install the plastic gutter rail ends as shown below.

Required parts include:

- 65841 (left hand fixture)
- 65842 (right hand fixture)

Greenhouse Sku Number	Work from this box:
104564	C/No. 7-5
103967	C/No. 9-5

1. Locate the fixtures identified above and install these as shown below for one side of the assembled frame.

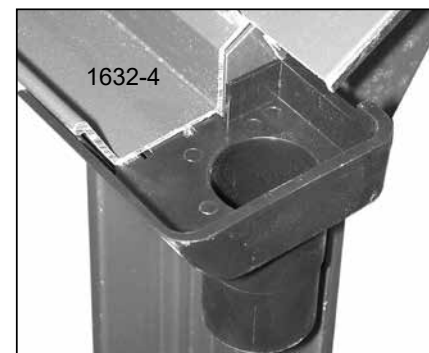
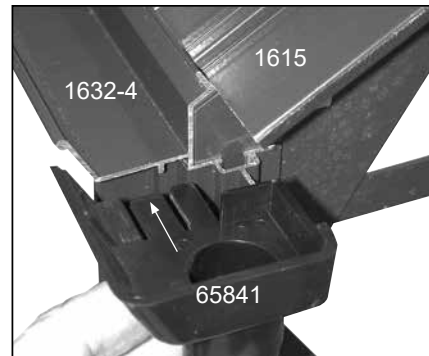

2. Repeat the steps for the remaining ends of the gutter rails.
3. Continue with installing the side, end, and roof polycarbonate panels.

ATTENTION: TO AVOID TWISTING OFF OR DAMAGING THE FASTENERS, DO NOT OVERTIGHTEN.

FOR YOUR CONVENIENCE, ADDITIONAL FASTENERS CAN BE FOUND IN THE "EXTRA PARTS" BAG OR BOX. REFER TO THE BILL OF MATERIALS FOR A LIST OF THE FASTENERS CONTAINED IN THAT BAG OR BOX.

INSTALL THE POLYCARBONATE PANELS

The remaining panels are installed based on the diagram found on the outside of each shipped box. For best results, follow these basic instructions to install the final panels:

1. Consult the panel installation and U-profile diagrams at the back of these instructions and on the boxes that contain the polycarbonate panels.
2. Work from one box only until all panels and U-profile are installed from that box.
3. Do not cut any U-profile or panels!
4. Do not allow panels to remain in direct sunlight until all protective film is removed and the panels are installed.
5. Wipe all frame surfaces with alcohol or other residue-free solvent in locations where silicone will be applied.

NOTE: Use solvents or alcohol as directed by those manufacturers. Ensure adequate ventilation.

6. Always rest panels on a clean surface when installing. Do not allow the panels to rest on the ground.
7. Install the UV-protected side to the outside (or toward the sun).
8. Do not install during windy or wet conditions. The installed panels must be protected from the elements to allow the silicone to set.
9. If desired, seal the open cells at the top edge of each panel with tape or with silicone *before installing the U-profile* to prevent dirt from entering the cells.

NOTE: Do not seal the bottom of any panel with silicone. These cells must remain open and free of debris to allow condensation to drain from the panel cells. (See Item 10 for optional vent tape purchase.)

10. Vent tape (additional purchase required): If vent tape was purchased, apply this tape at the bottom of each polycarbonate panel *before* installing the U-profile. Vent tape is not required but helps keep dirt from inside the cells and allows condensation to drain from the cells.
11. Purchase additional silicone if needed. The size of the bead of silicone used determines the amount of silicone required to secure and seal the remaining panels. It may be necessary to purchase additional silicone locally to complete the panel installation.

NOTE: An 1/8" bead is typically sufficient to seal and secure a panel to the greenhouse frame.

12. Consult the previous panel installation steps to review the basic installation steps.
13. Start the remaining panel installation *at the door end of the frame*. Use the diagrams attached to each shipped box as guides when installing the panels.

INSTALL THE FIRST SECTION OF PANELS

Use the following information when installing the first set of panels to cover the sides and roof of the greenhouse frame:

Greenhouse Sku Number	For wire clips, use box:
104564	C/No. 7-2
103967	C/No. 9-2

Greenhouse Sku Number	For panels, use box:
104564	C/No. 7-6
103967	C/No. 9-6

You do not need to cut any plastic molding. To prevent damage or injury, DO NOT install panels on a windy or stormy day.

ATTENTION: Install the polycarbonate panel with the UV-protected side to the outside of the greenhouse. If you remove the protective film before installing the panel, mark the panel in a lower corner so that the panel is installed correctly.

1. Locate the first sidewall panel from the box identified in the table and the U-profile for that panel and prepare the panel as previously described.
2. Carefully peel the protective film away *from the edge* on both sides of the panel.

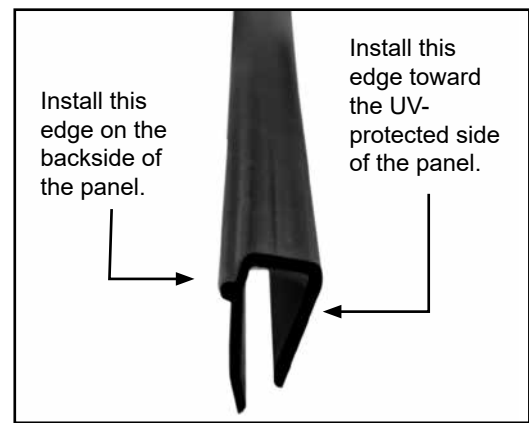

Plastic U-Profile

Do not completely remove the protective film until the plastic U-strips are installed.

3. Take one section of U-profile and install it on the top edge of the polycarbonate panel. If desired, you can *seal the top edge of the panel before* the U-profile is installed. (See the next photo.)

NOTE: The top and bottom edges of the panel show the hollow cells inside the panel. When installing the plastic molding, rest the panel on cardboard or other material to protect the edges and surface of the panel.

GROWSPAN™ ESTATE PRO I GREENHOUSES

INSTALL FIRST SECTION OF PANELS (CONTINUED)

4. Take another section of U-profile and attach it to the bottom edge of the panel.

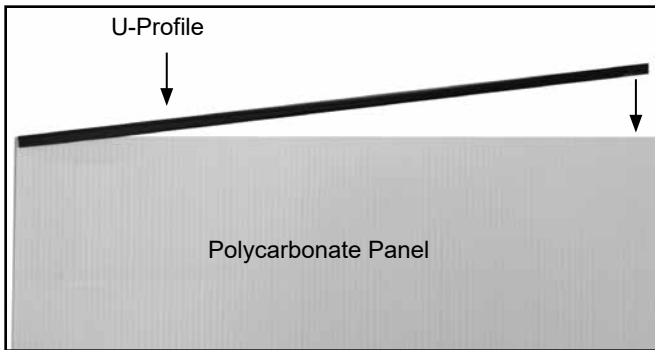
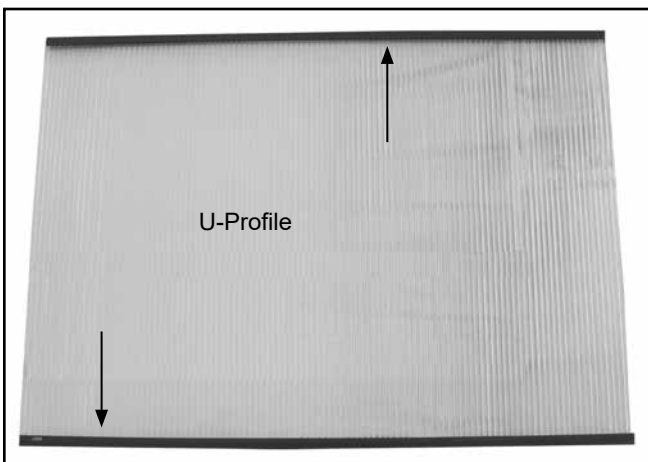

Photo is used to illustrate the location of the U-profile.
The panel size may differ from the actual panel.



5. Move to the frame where the panel will be installed and clean the surfaces where the silicone will be applied.

NOTE: The surface for the silicone on the frame must be free of oil and dirt for best results. See the profile and panel diagrams and photo to the right for silicone location.

6. With the plastic U-strip installed and the surface cleaned, dry fit the panel to verify that it fits between the frame members.
7. Remove the protective film from the panel and mark the UV-protected side with a piece of tape or a marker and set the panel aside.

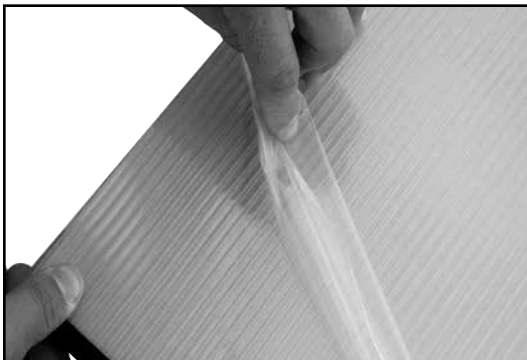

8. Move to the frame and, standing outside the frame, apply a bead of silicone *in the channel of each frame member* in the areas shown below by the dashed lines.

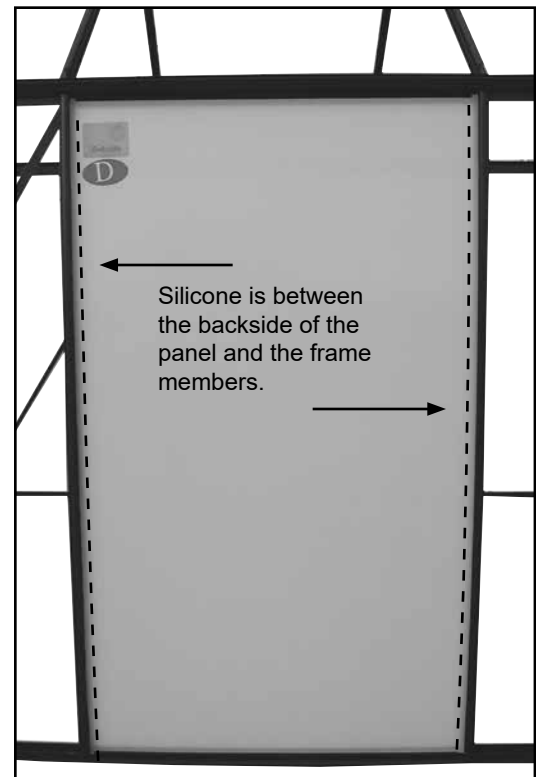
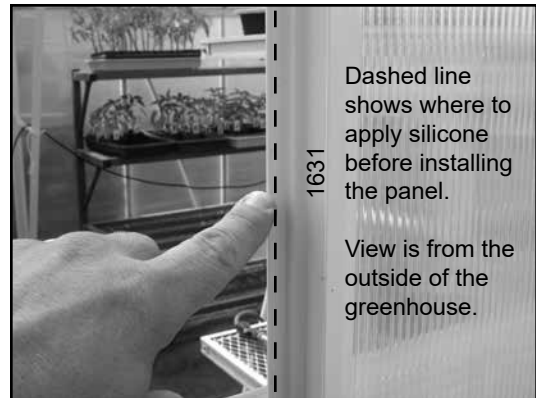

ATTENTION: Panel is shown in place to better show the location of the silicone, which is applied *before* the panel is set in the frame.

9. After the silicone is applied, take the prepared panel and set the panel into position as shown above. *Panel as seen from the outside.*

NOTE: Protective film has been left in place to better show the panel.

10. Firmly press the panel against the silicone on the rafter. Panel will sit between the frame members.
11. Continue by installing the metal clips to secure the panel to the frame.

INSTALL METAL RETENTION CLIPS

There are two sizes of wire clips used to secure the panels to the frame (1682 and 1687). CONSULT THE SPRING CLIP DIAGRAMS NEAR THE BACK OF THESE INSTRUCTIONS FOR PROPER INSTALLATION LOCATIONS.

Continue with the following steps to install the clips on the outside of the greenhouse.

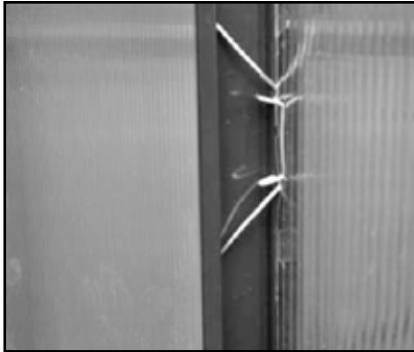

CAUTION: Wear eye protection when installing and working with the wire clips.

1. With the panel in place, take a wire clip and place it against the sidewall vertical support and panel.

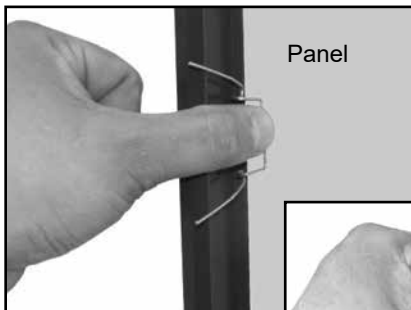

Place wire clip into position as shown.

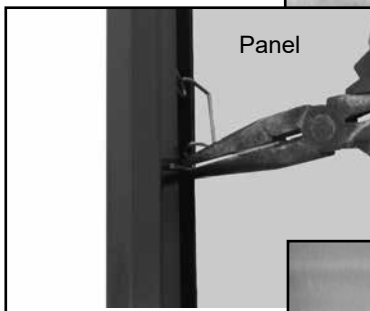
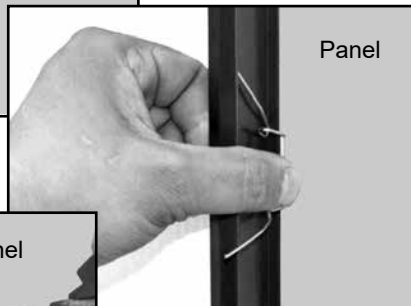

Use a pliers if needed to clip the spring in place.

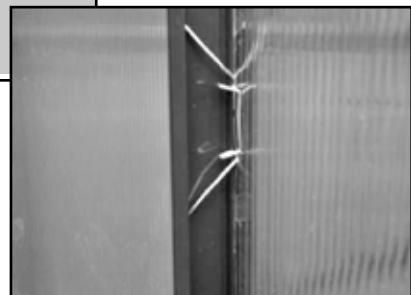

2. Clip the free ends of the wire spring behind the lip of the frame member and press into place.

NOTE: Refer to the diagram for the correct wire spring size and to properly space the wire clips.

3. After securing the first polycarbonate panel to the frame, repeat the steps to prepare and install all remaining panels from the box.
4. After the first set of panels is installed, continue by installing the panels from the remaining boxes. Use the tables below and the diagrams attached to the outside of each shipping package to continue.

INSTALL NEXT SET OF PANELS

Refer to this table when selecting the next boxes to work from for your greenhouse.

Greenhouse Sku Number	For wire clips, use box:
104564	C/No. 7-3
103967	C/No. 9-3

Greenhouse Sku Number	For panels, use box:
104564	C/No. 7-7
103967	C/No. 9-7

Complete these steps:

1. Using the previous panel installation instructions, install the next set of polycarbonate panels. Refer to the diagrams for locations and panel identification.
2. Continue by completing the instructions for your greenhouse:

For greenhouse 104564, continue with the end wall panel installation procedures.

For greenhouse 103967, continue with the instructions below.

INSTALL NEXT SET OF PANELS: 103967 Only

Refer to this table when selecting the next boxes to work from for your greenhouse.

Greenhouse Sku Number	For wire clips, use box:
103967	C/No. 9-8

Greenhouse Sku Number	For panels, use box:
103967	C/No. 9-9

Complete these steps:

1. Using the previous panel installation instructions, install the next set of polycarbonate panels. Refer to the diagrams for locations and panel identification.
2. Continue by installing the end wall panels.

GROWSPAN™ ESTATE PRO I GREENHOUSES

INSTALL THE END WALL PANELS

The end panels are installed and secured in the same manner as the other polycarbonate panels: The U-profile is installed at the top and bottom of each panel; the wire clips are installed along each side. Only the panel shape differs.

NOTE: All end panels are cut to the proper size. You do not have to cut any polycarbonate panels.

Use the table below to identify where to find the panels and clips needed to complete the end wall panel installation.

Greenhouse Sku Number	For wire clips, use box:
104564	C/No. 7-1
103967	C/No. 9-1

Greenhouse Sku Number	For panels, use box:
104564	C/No. 7-5
103967	C/No. 9-5

Complete these steps:

1. Using the previous panel installation instructions, install the polycarbonate panels for the end walls. Refer to the diagrams for locations and panel and profile identification.
2. Continue by installing the ridge beam end cover, the remaining door hardware, and rain downspouts.

INSTALL THE RIDGE BEAM END COVERS

The end covers are used to close the opening at each end of the ridge beam that runs the length of the greenhouse at the peak of the greenhouse frame.

Consult the following table to locate the required end covers and mounting screws:

Greenhouse Sku Number	For end cover, use box:
104564	C/No. 7-2
103967	C/No. 9-2

Complete these steps:

1. Locate the end covers (1659) and the mounting screws.
2. Using the proper lift or ladder to reach the ridge beam, attach the end covers to the ends of the ridge beam.

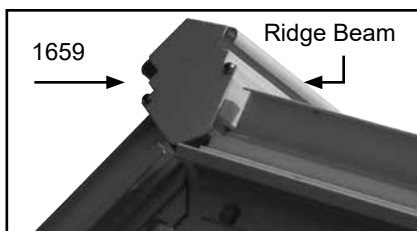

End covers and mounting screws are packaged together.

3. Continue with the installation of the door hardware and the rain downspouts.

Space below reserved for customer notes.

EXTRA PARTS PROVIDED FOR GREENHOUSE

ATTENTION: TO AVOID TWISTING OFF OR DAMAGING THE FASTENERS, DO NOT OVERTIGHTEN.

FOR YOUR CONVENIENCE, ADDITIONAL FASTENERS AND PLASTIC MOLDING CAN BE FOUND IN THE "EXTRA PARTS" BAG OR BOX.

REFER TO THE BILL OF MATERIALS FOR A LIST OF THE FASTENERS AND MOLDING CONTAINED IN THAT BAG OR BOX.

The plastic profile can be trimmed to the required length if a piece is misplaced or damaged during installation.

IMPORTANT: Consult the "extra parts" for items you need before contacting customer service to request a replacement for damaged or missing parts or fasteners.

ATTACH MAGNETIC DOOR STOPS TO THE FRAME

A magnetic doorstop is attached to the assembled frame for each of the door sections. Parts are located in these boxes:

Greenhouse Sku Number	For door parts, use box:
104564	C/No. 7-4
103967	C/No. 9-4

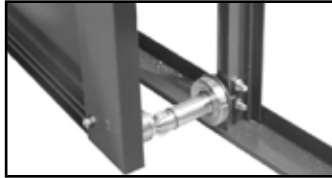
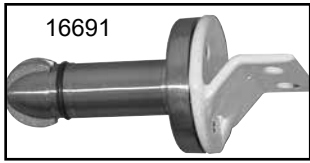

Complete these steps:

1. Locate the required doorstops and related brackets.
2. Attach the magnetic stop to the vertical support by inserting the mounting bolts through the pre-drilled holes in the vertical support.

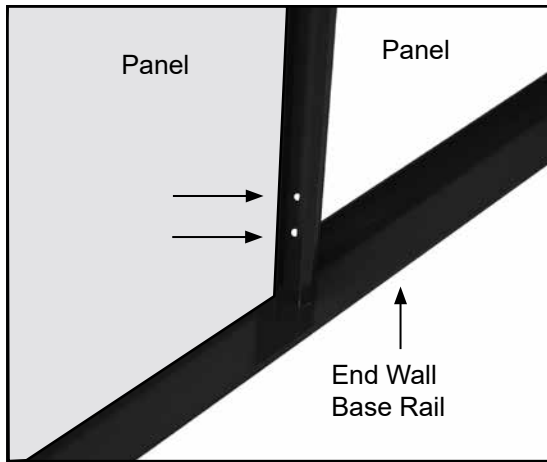
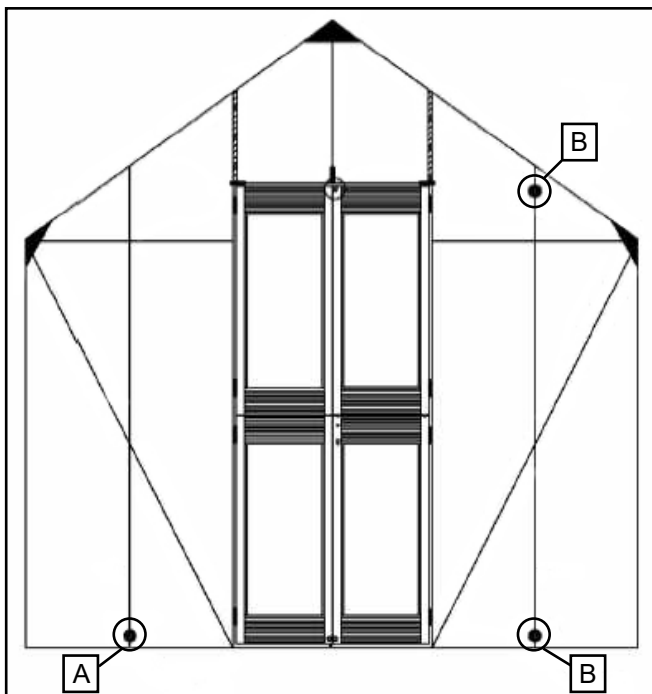
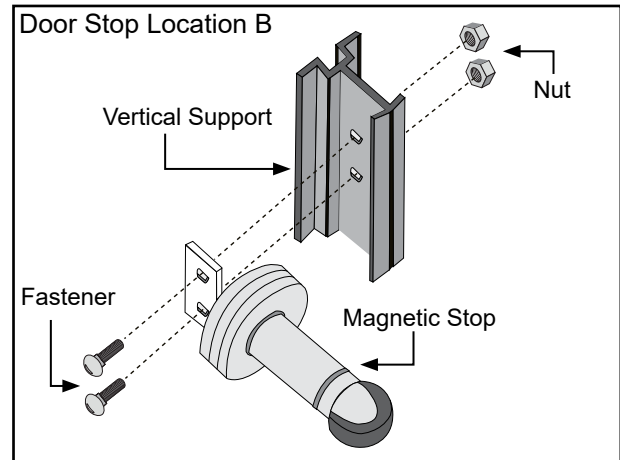
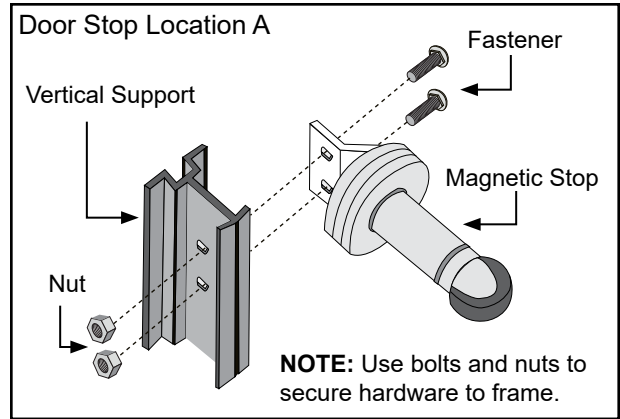

Diagram below shows the door stop locations.



ATTENTION: Attach the doorstop to the vertical support as shown below. Verify that the stop is aligned with the *mating bracket attached to each door frame before* you secure the magnetic door stop to the frame member.

Fasteners shown may differ from actual fasteners. They are used for illustration.



3. Repeat the steps to attach the remaining doorstops.
4. Attach all remaining doorstops.
5. After the doorstops are in place, locate the weatherstripping and attach it to the door frame of the end wall. See the dashed line below.

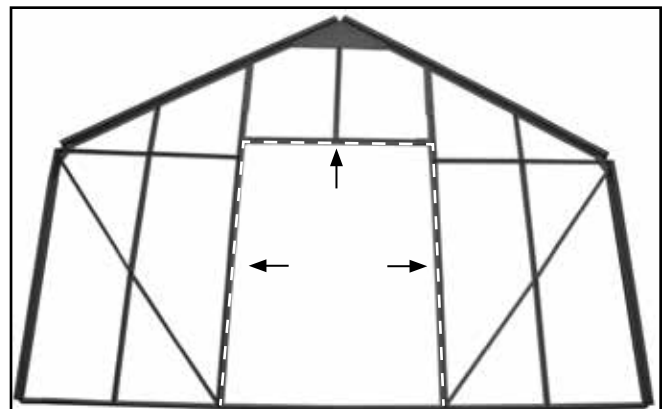

6. After the doorstops are in place, continue by installing the downspouts for the gutter.

GROWSPAN™ ESTATE PRO I GREENHOUSES

INSTALL THE DOWNSPOUTS

Consult the following table to locate the parts.

Greenhouse Sku Number	For downspouts, use box:
104564	C/No. 7-5
103967	C/No. 9-5

1. Locate the plastic drain pipe clamps (1685) and the drain pipes (1686) for the gutter.

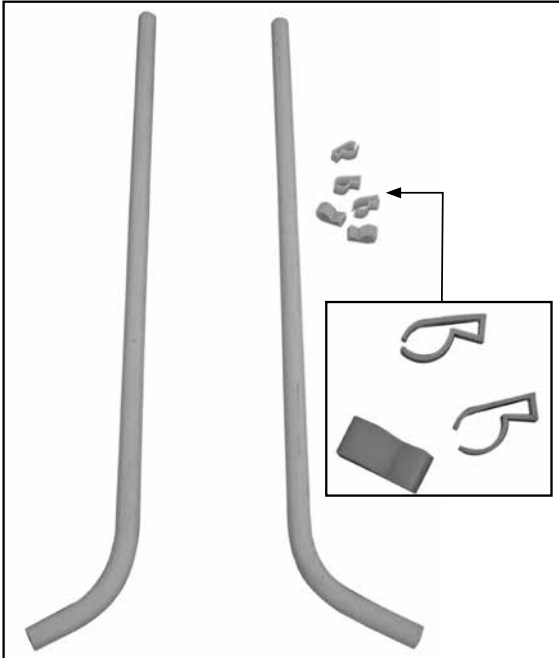

2. Move to one corner, position the bracket as shown, mark the location, and drill the hole through the end wall frame member (if needed).

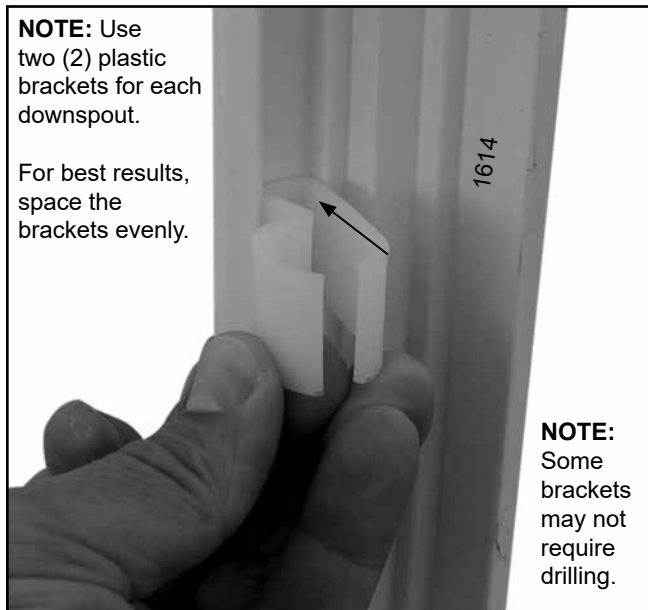

3. Attach the plastic clamps to the end wall lower support using bolts. Arrow shows where to install bolt for the clamp.

4. Repeat the steps as needed to attach the remaining clamp for the first downspout.
5. Once all clamps are in place for one drain pipe, place the pipe in position and connect it to the fixture attached to the gutter rail.

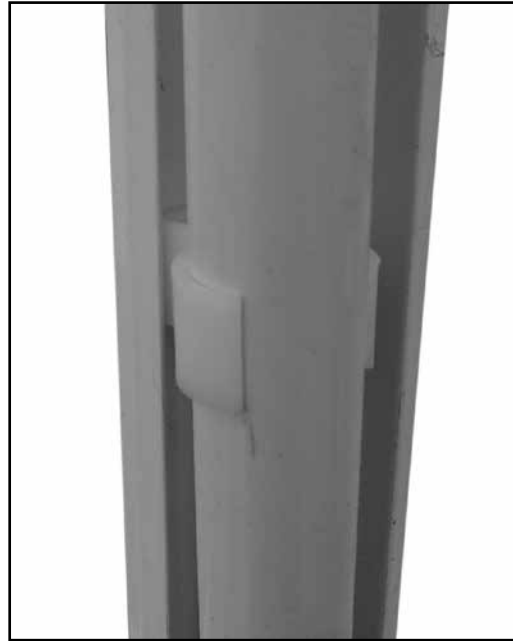

6. Repeat the steps for the remaining drain pipes.
7. Continue by reading the care and maintenance information that follows.

ATTENTION: TO AVOID TWISTING OFF OR DAMAGING THE FASTENERS, DO NOT OVERTIGHTEN.

FOR YOUR CONVENIENCE, ADDITIONAL FASTENERS CAN BE FOUND IN THE "EXTRA PARTS" BAG OR BOX. REFER TO THE BILL OF MATERIALS FOR A LIST OF THE FASTENERS CONTAINED IN THAT BAG OR BOX.

Space below reserved for customer notes.

CARE AND MAINTENANCE

Proper care and maintenance of the greenhouse will help to ensure years of service. The following items identify areas that should be periodically checked to ensure that your greenhouse is maintained properly:

- Check connections and all fasteners to verify that they remain tight.
- Check the anchor system regularly. Tighten all bolts and nuts and related hardware (if needed and if applicable).
- Do not climb or stand on the greenhouse at anytime.
- Remove debris and objects that can accumulate on the greenhouse. Use tools that will not damage the greenhouse when removing debris.
- Remove snow to prevent excess accumulation. Use tools that will not damage the greenhouse when removing snow.
- Check the contents of the greenhouse to verify that nothing is touching the sides that could cause damage.
- Depending on the contents and greenhouse location, the potential for condensation exists. Growspan™ offers several items that can help to alleviate a condensation condition. Please contact a Growspan™ representative for additional information at 1-800-245-9881.
- Consult the instructions included with the solar vent openers for proper care and maintenance of these openers (if equipped).
- Check the solar vent opener mounting brackets and screws to see they remain secure (if equipped).
- Replace damaged panels.
- For replacement or missing parts, call 1-800-245-9881 for assistance. For the solar vent openers, consult the documentation included in the packaging of the opener.



QUICK START GUIDE

Estate Pro I Greenhouses



Model shown above may differ from actual model.

OPTIONAL BASE ASSEMBLY

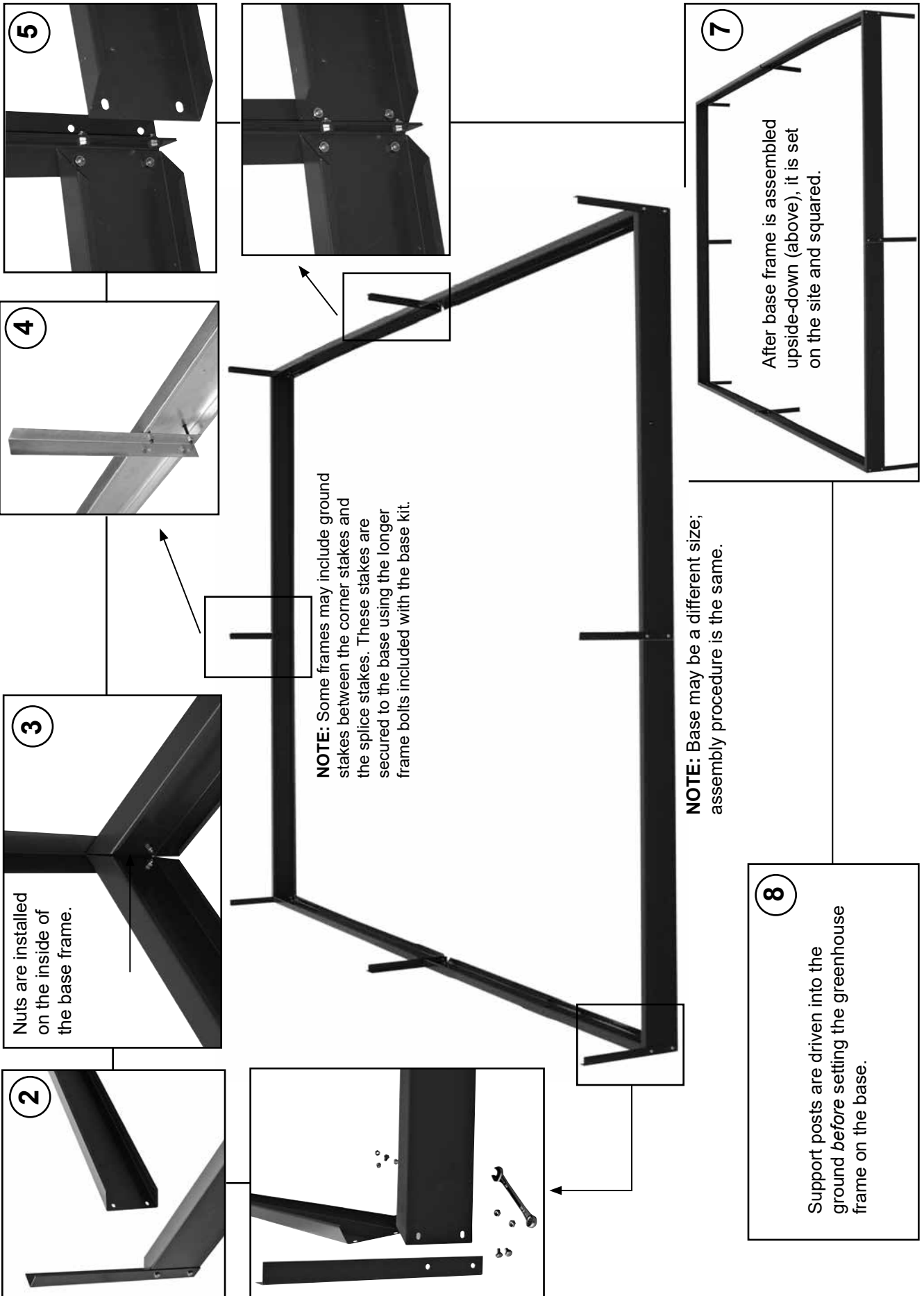

END FRAME DIAGRAM - DOOR END

*View shows the *inside (or bolt track)* surface of the end wall.

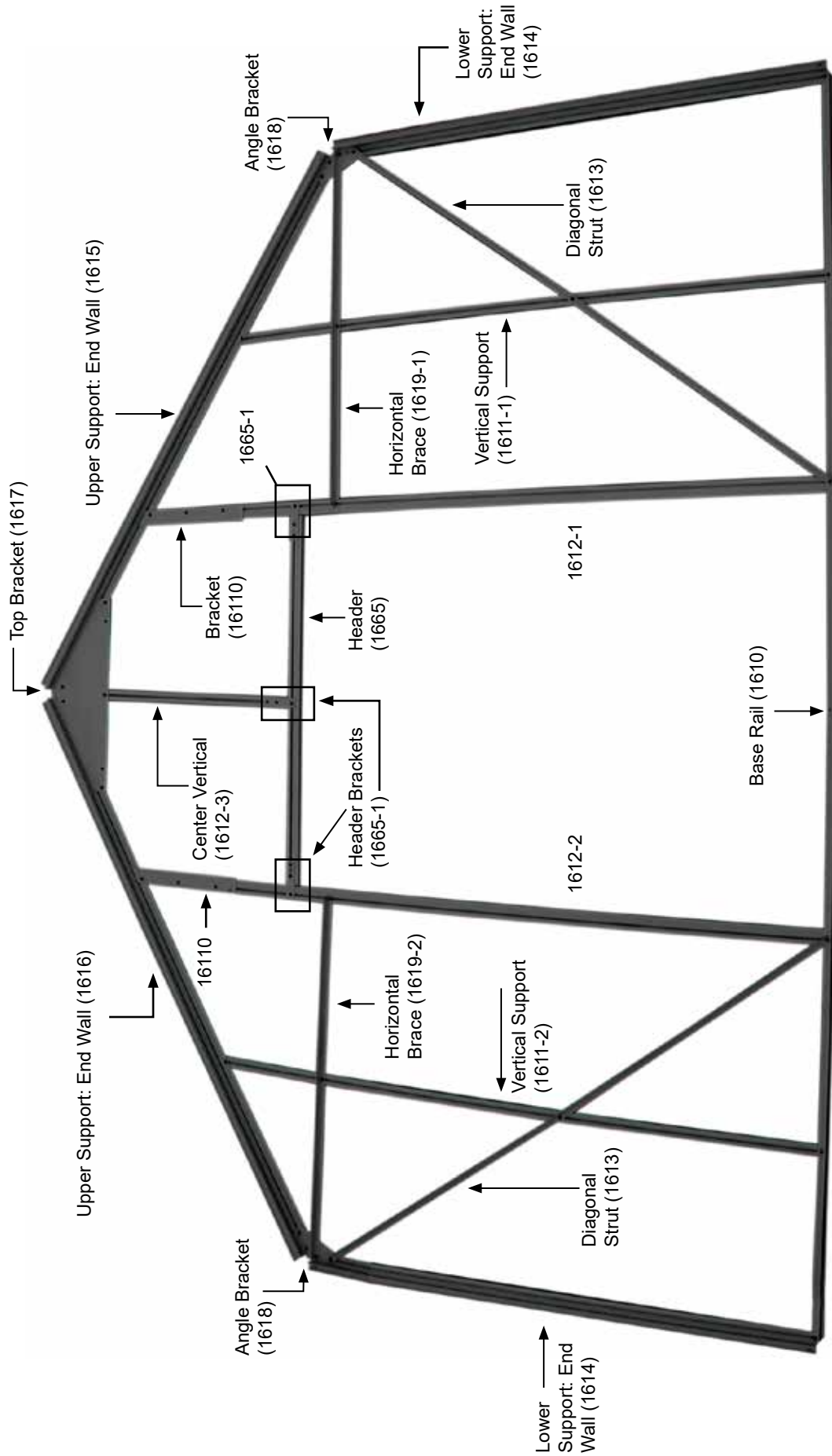

ATTENTION: Part numbers are stamped on the part.

END FRAME DIAGRAM - NO DOOR

*View shows the *inside* (or *bolt track*) surface of the end wall.

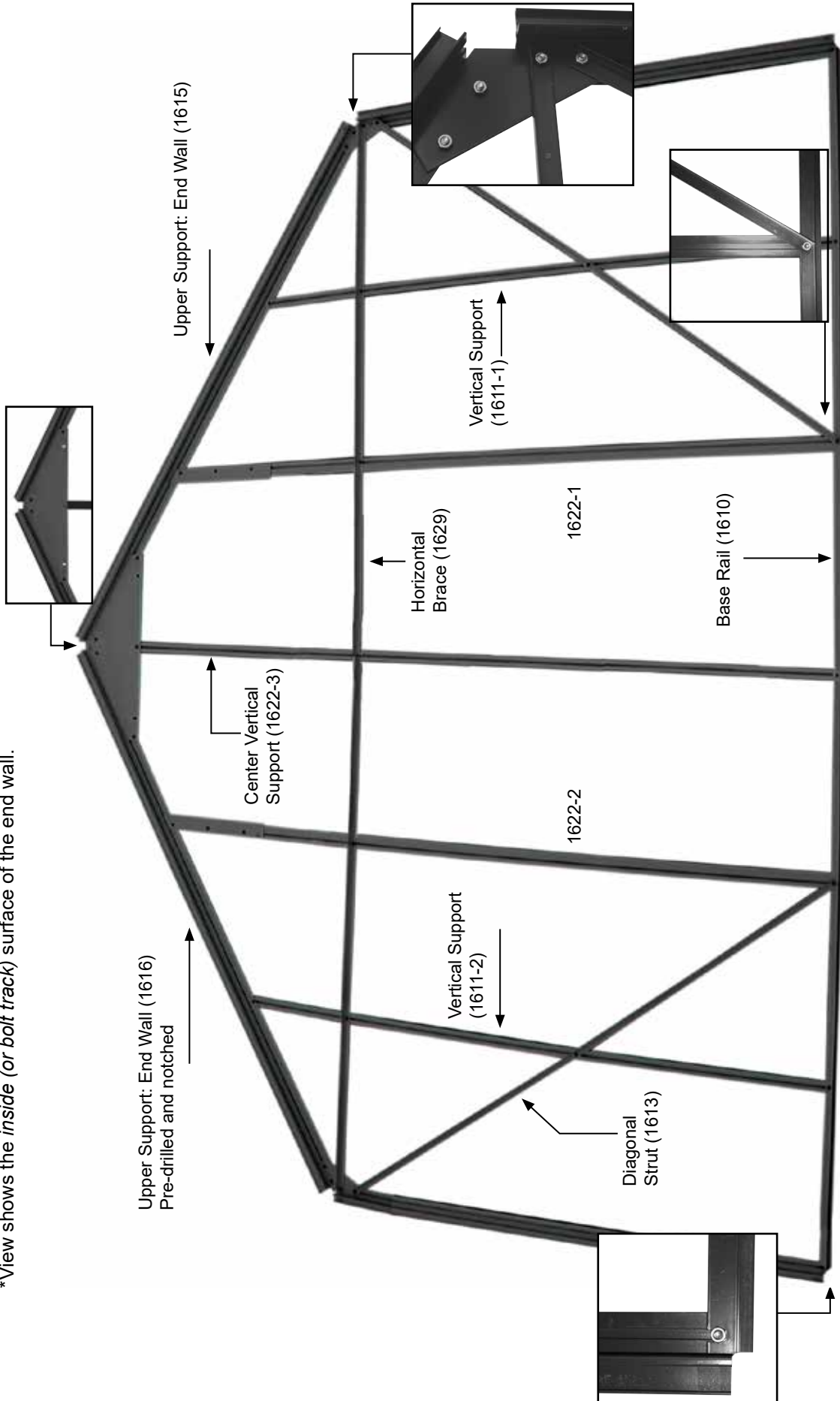

ATTENTION: Part numbers are stamped on the part. The parts that are not identified above have the same numbers as those shown on the End Frame Diagram: Door End.

SIDEWALL FRAME DIAGRAM - 104564

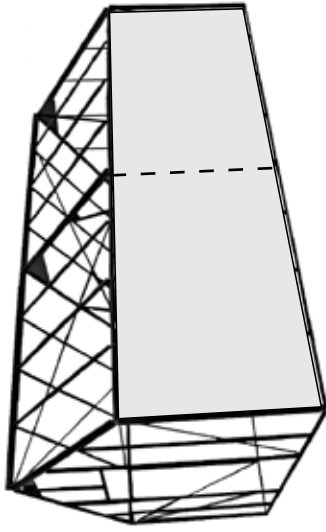

ATTENTION: Use the M6x13 bolts in the locations identified by the circles in the diagram below.

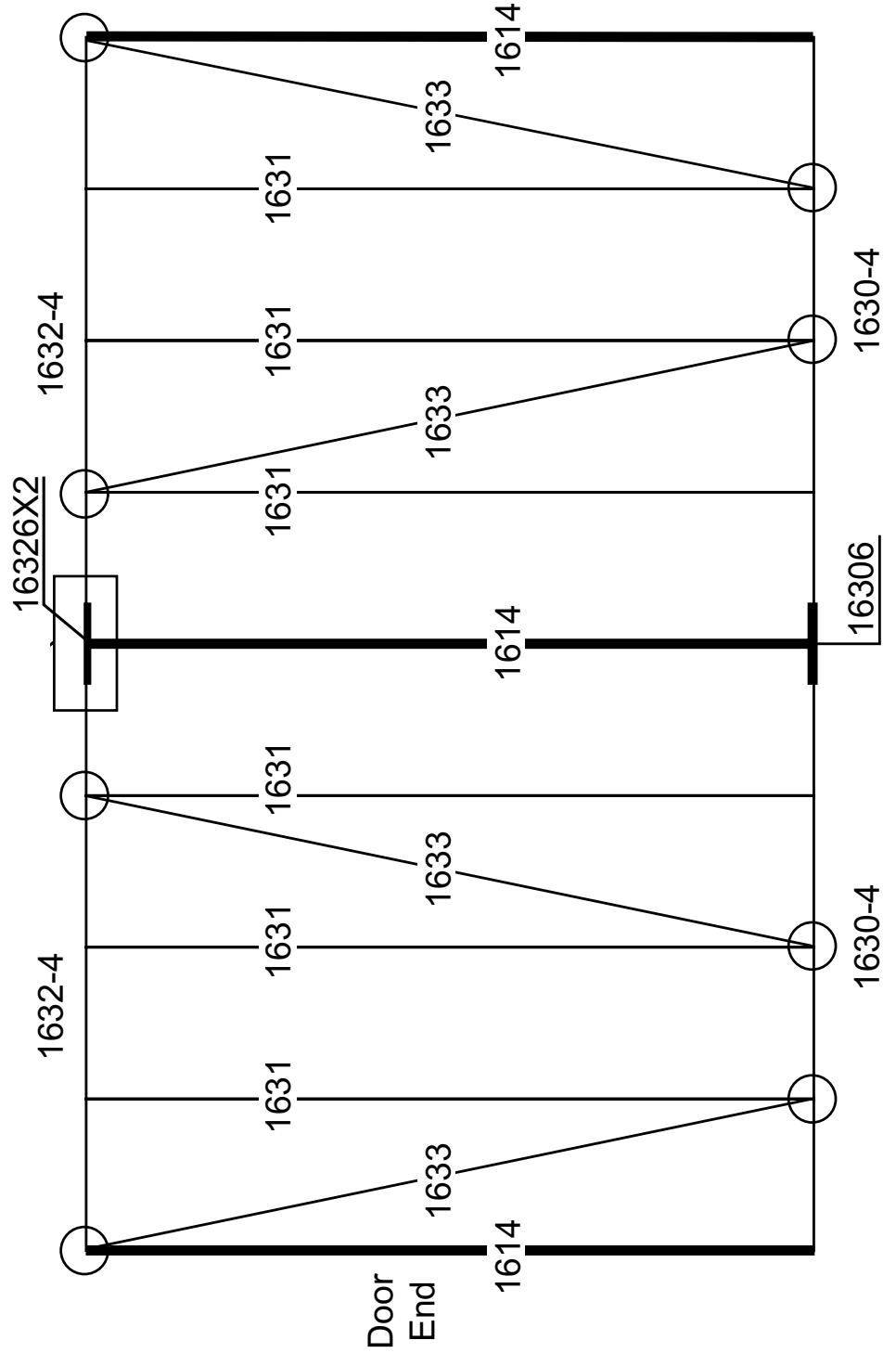

SIDEWALL FRAME DIAGRAM - 103967

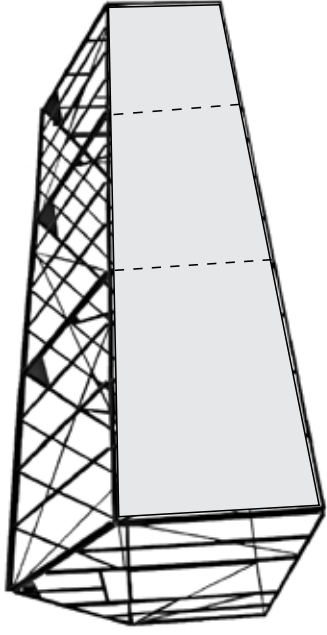

ATTENTION: Use the M6x13 bolts in the locations identified by the circles in the diagram below.

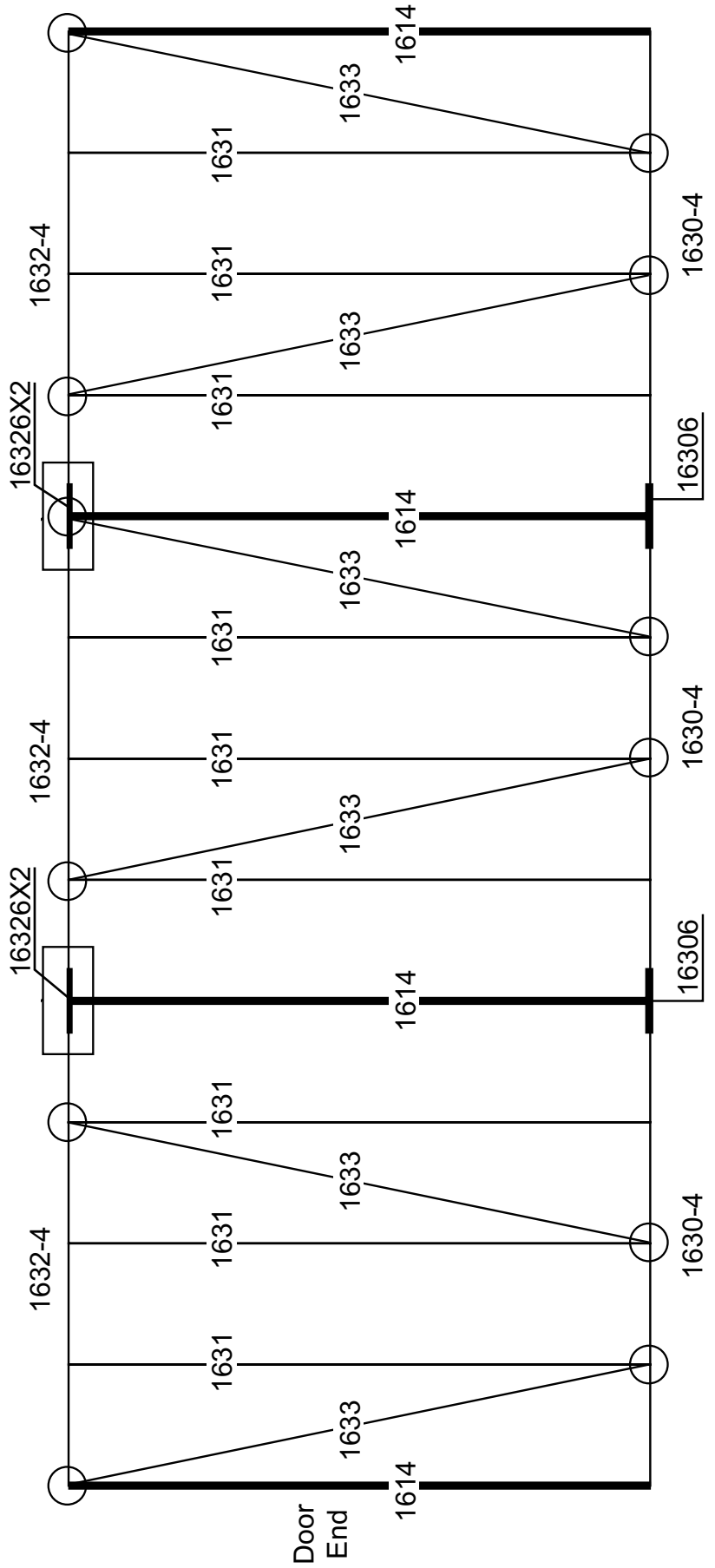

SIDEWALL SUPPORTS: TOP VIEW

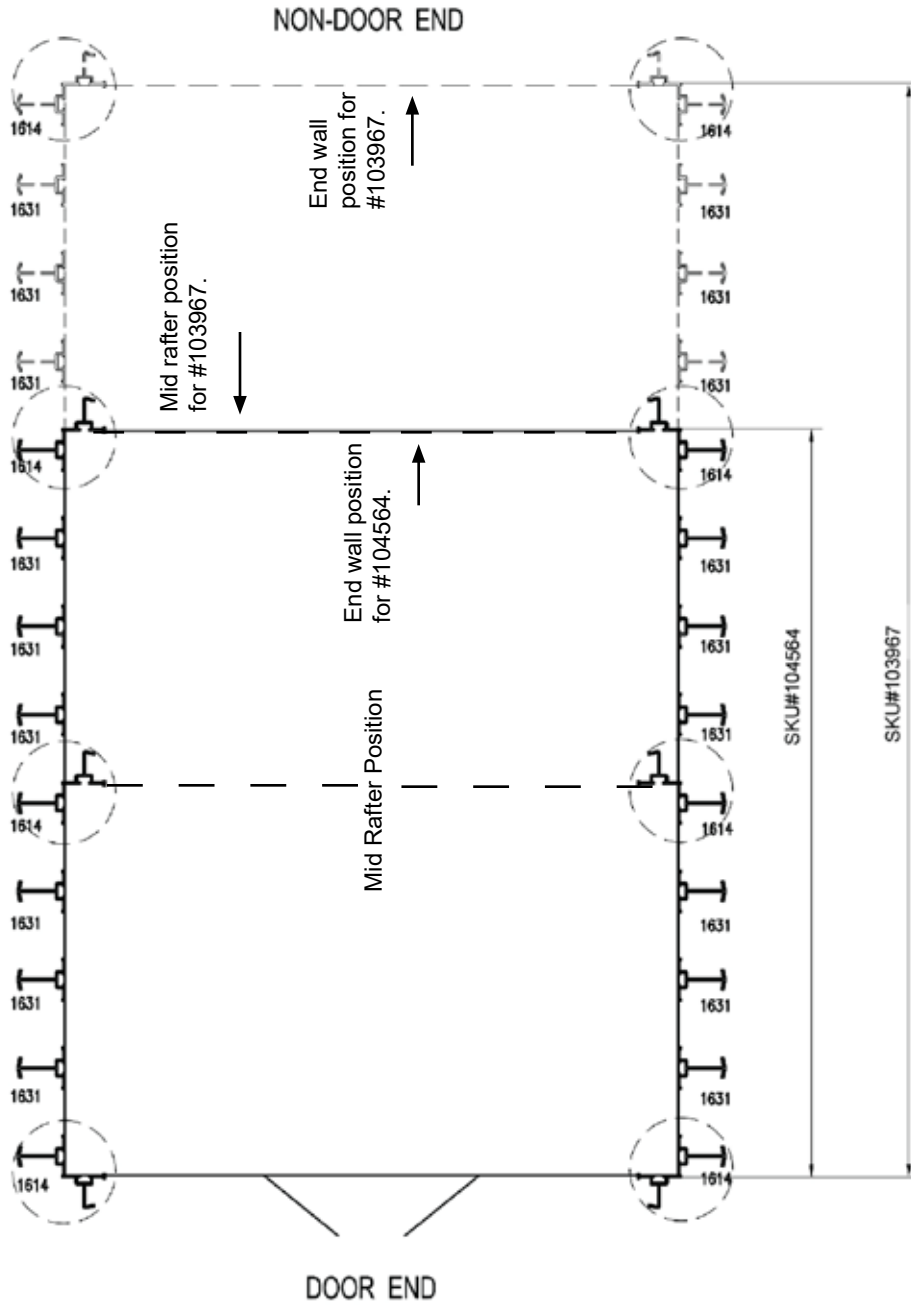

ATTENTION: Use this diagram for reference when attaching the assembled sidewall frames to the end wall frames and when setting the assembled mid rafters in position.

The frame members must be assembled as shown to allow proper placement of the side and roof panels.

ROOF FRAME DIAGRAM - 104564

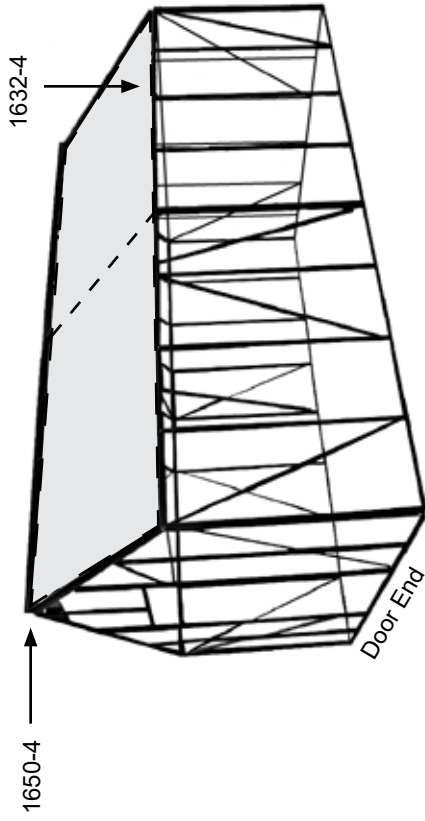

ATTENTION: Use this diagram when assembling the roof section of the 104564 greenhouse. The circles show where additional bolts are slid into the track before the rafter is attached to the ridge beam (1650-4) and the gutter rail (1632-4).

These additional bolts are used to attach the diagonal braces (shown) and the vent framing and support are brackets.

Shaded area in the frame diagram (right) identifies the frame section shown below.

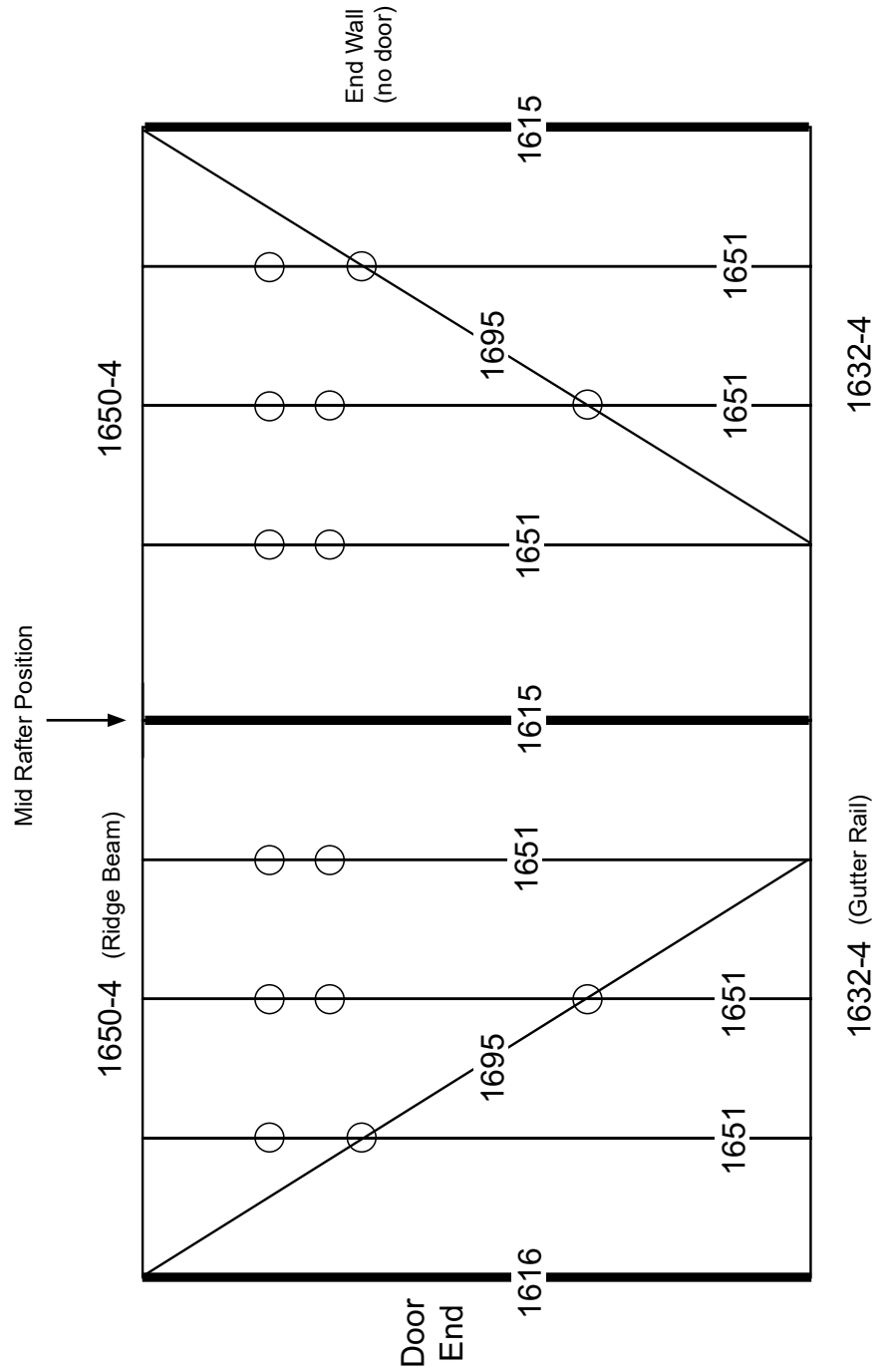

ROOF FRAME DIAGRAM - 103967

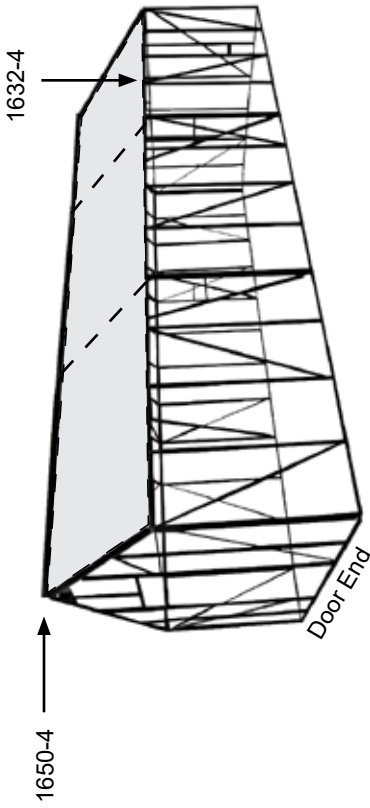

ATTENTION: Use this diagram when assembling the roof section of the 103967 greenhouse. The circles show where additional bolts are slid into the track before the rafter is attached to the ridge beam (1650-4) and the gutter rail (1632-4).

These additional bolts are used to attach the diagonal braces (shown) and the vent framing and support are brackets.

Shaded area in the frame diagram (right) identifies the frame section shown below.

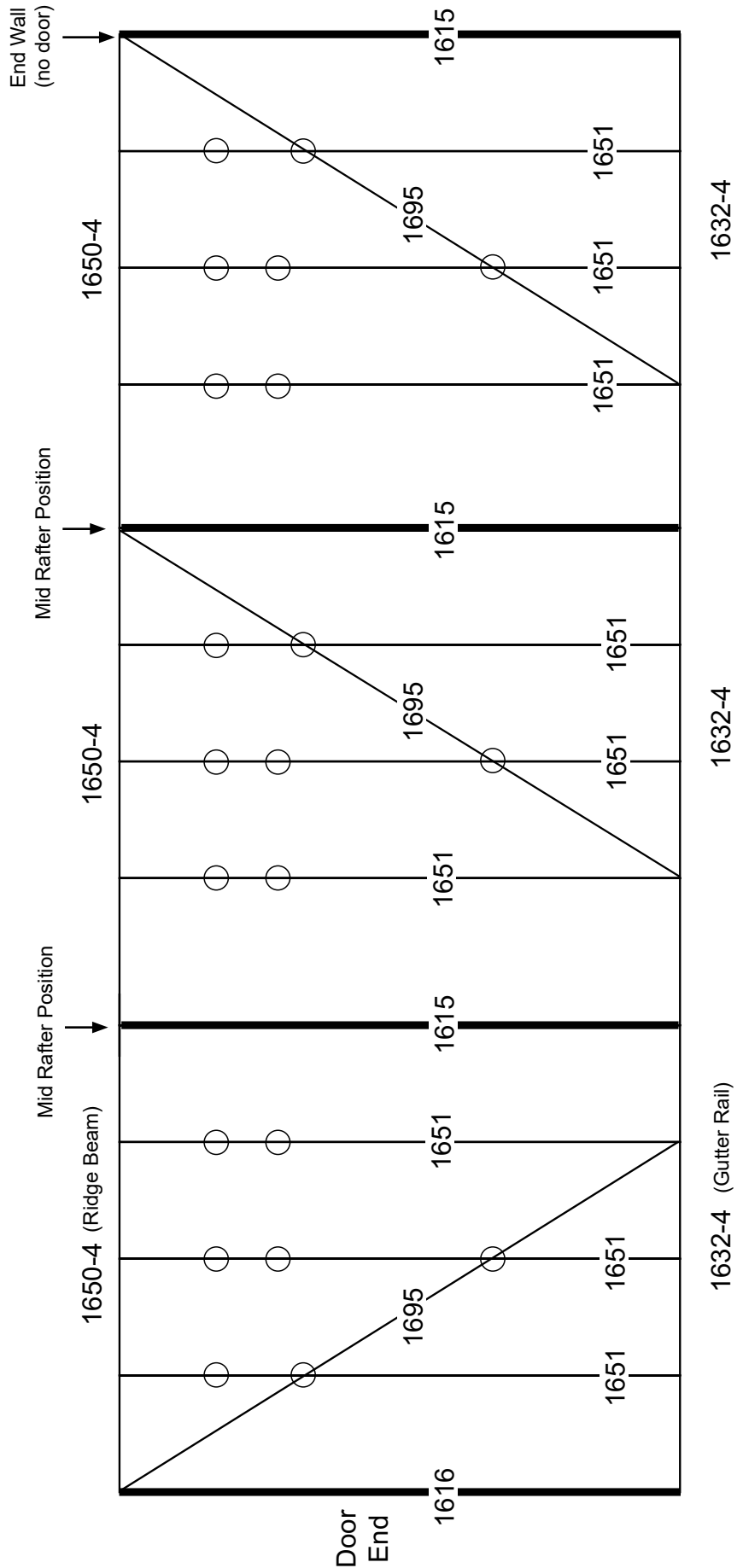

VENT FRAME DIAGRAM

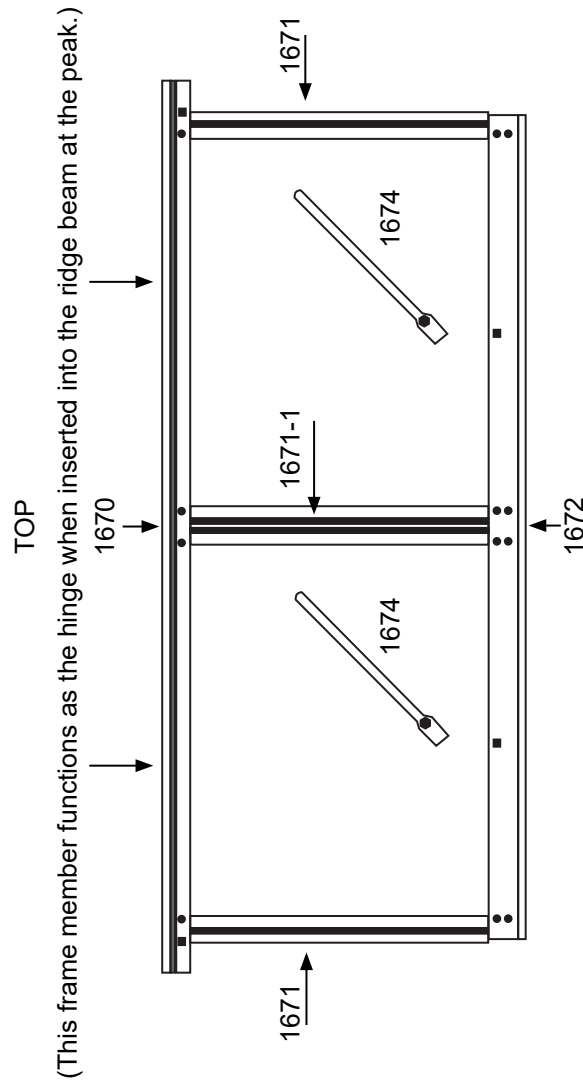

View shows the assembled vent frame from the back or underside. After the vent is installed, this surface is seen when standing inside the assembled greenhouse.

DOOR DIAGRAM

*View shows the back of the doors as seen from inside the greenhouse.
Some parts may come pre-assembled on the door frame.

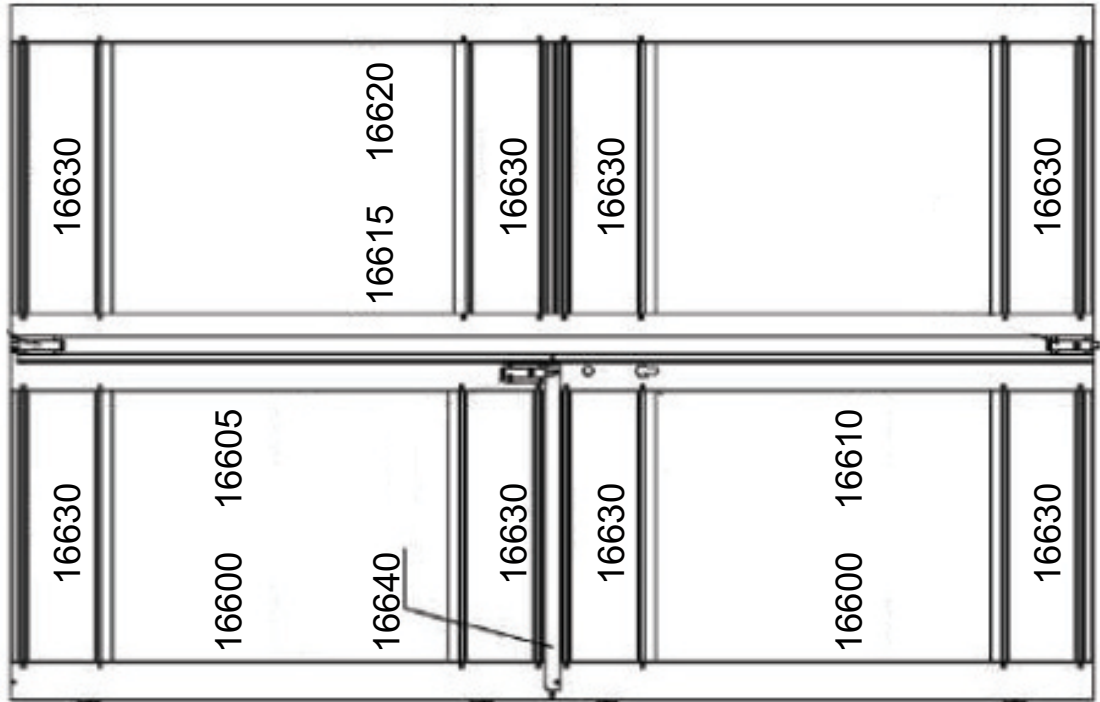

PANEL, PROFILE, AND SPRING LOCATION DIAGRAMS - 104564

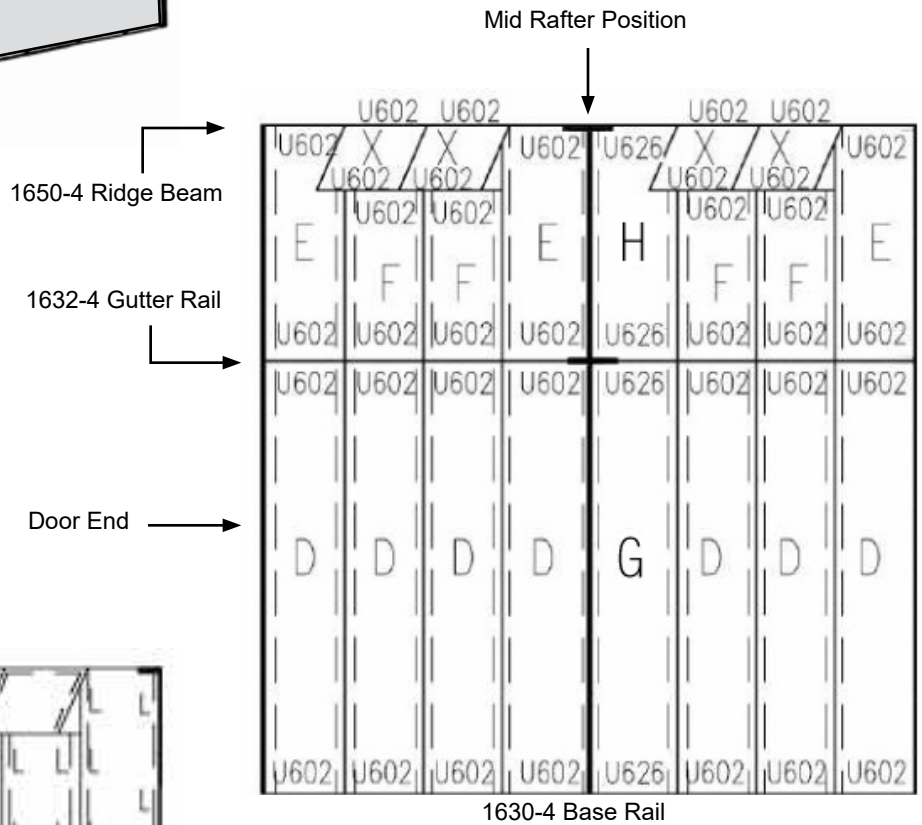
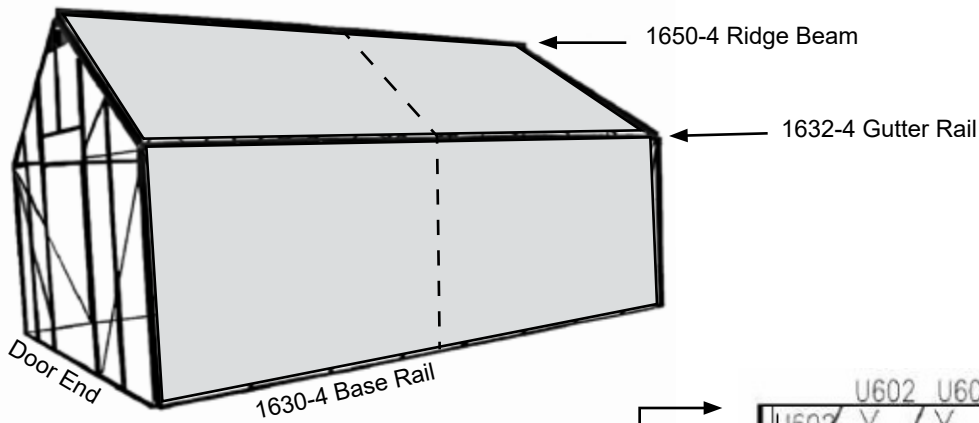

ATTENTION: In the diagrams, the letter U identifies the U-profile.

SIDE, VENT, AND ROOF PANEL IDENTIFICATION DIAGRAM

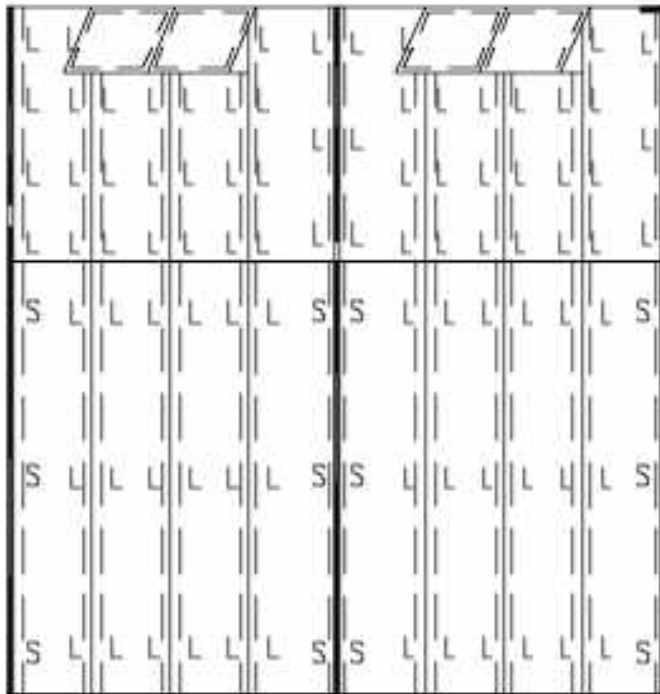

WIRE SPRING CLIP IDENTIFICATION AND LOCATION

S: Small Wire Spring Clip
 L: Large Wire Spring Clip

Dashed lines (left) show where to apply the silicone *before* setting the panels into place.

Vent panels are secured in place by silicone only.

PANEL, PROFILE, AND SPRING LOCATION DIAGRAMS - 103967

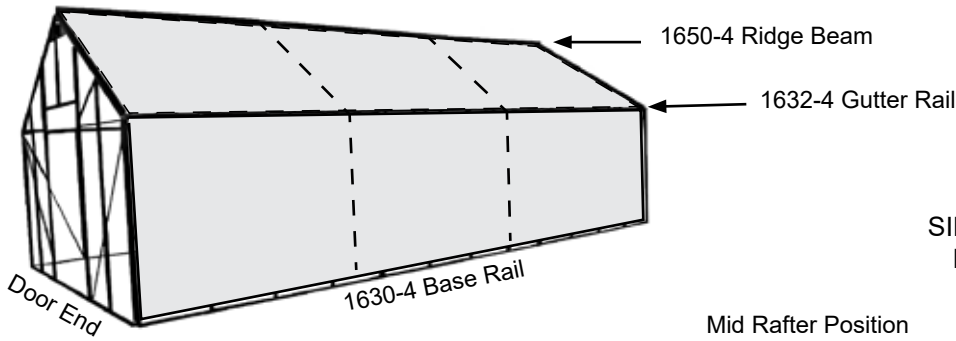

SIDE, VENT, AND ROOF PANEL IDENTIFICATION DIAGRAM

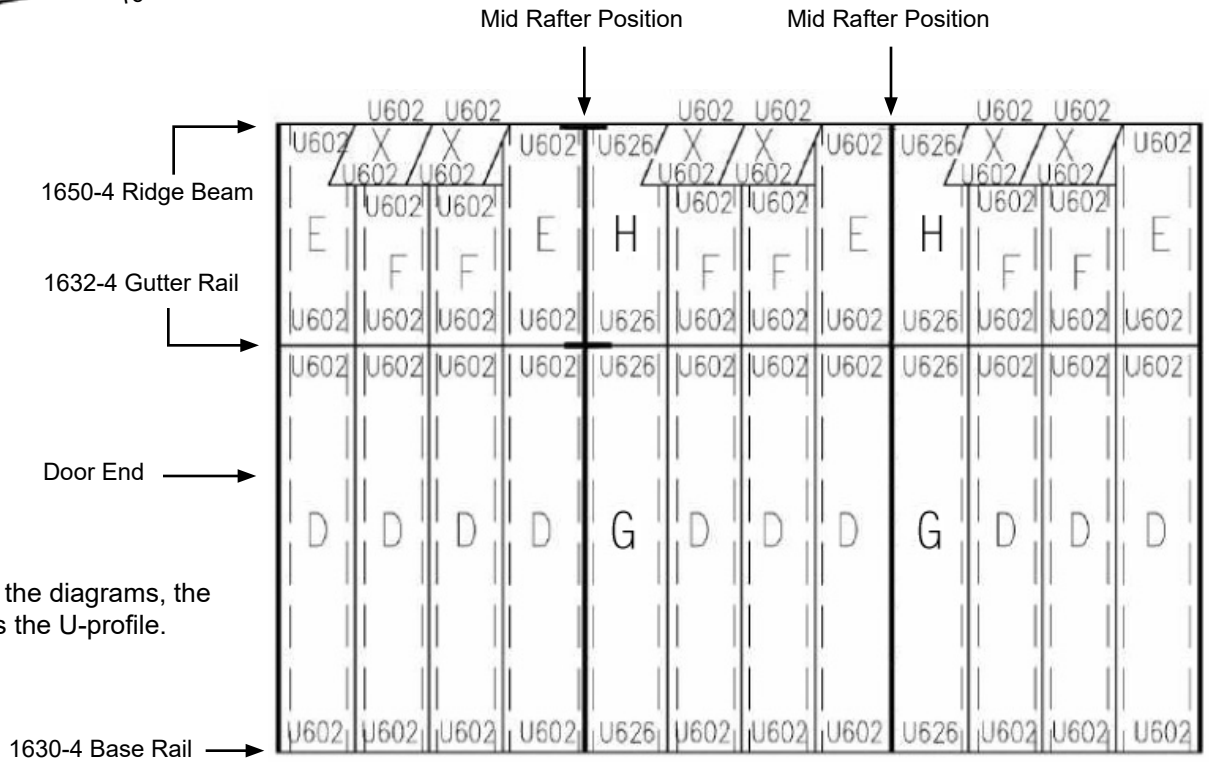

ATTENTION: In the diagrams, the letter U identifies the U-profile.

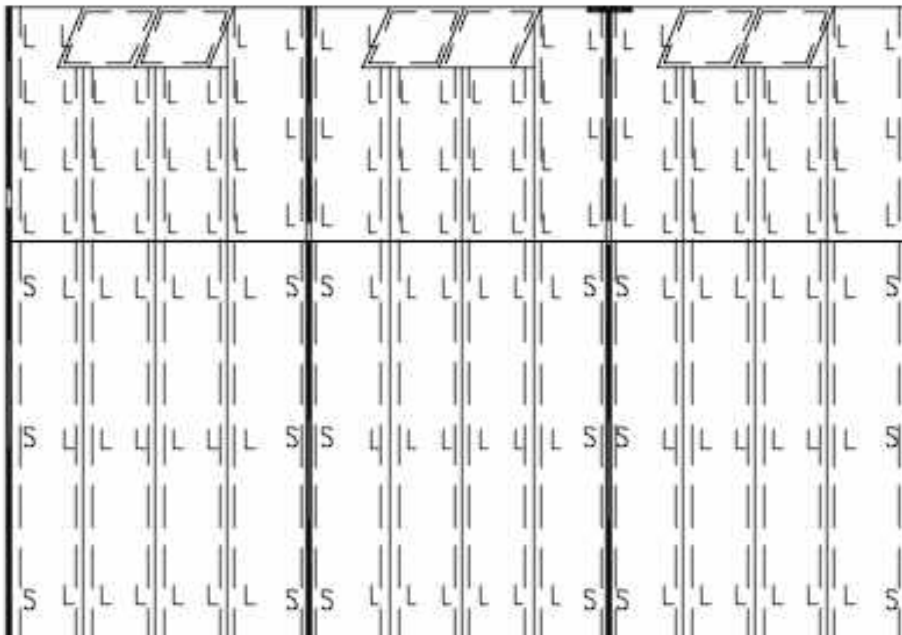

WIRE SPRING CLIP IDENTIFICATION AND LOCATION

S: Small Wire Spring Clip
 L: Large Wire Spring Clip

Dashed lines (left) show where to apply the silicone *before* setting the panels into place.

Vent panels are secured in place by silicone only.

END WALL PANEL, PROFILE, AND SPRING DIAGRAMS

*View shows Door End Panels - End Walls are the same for all models.

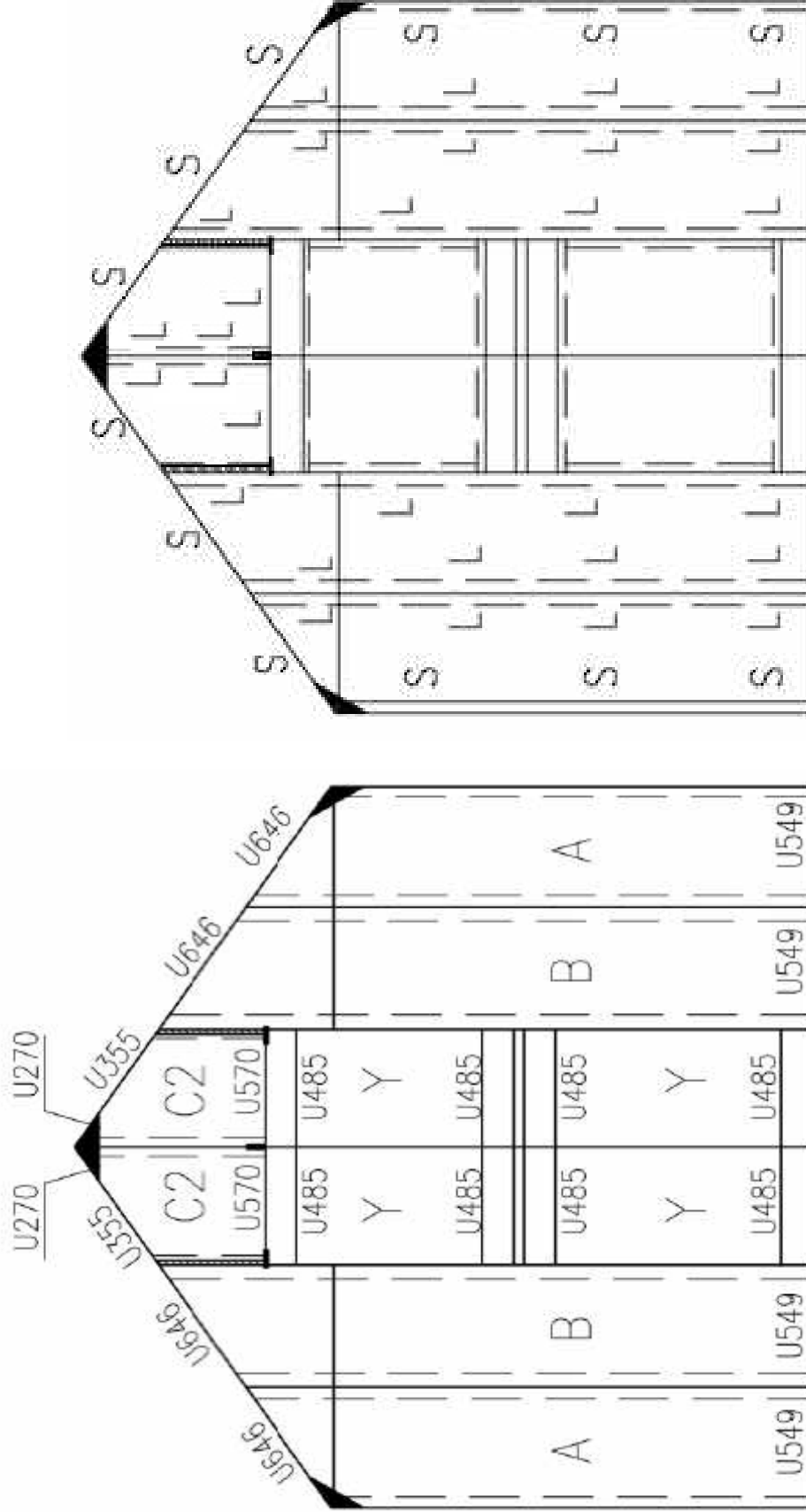

ATTENTION: In the diagrams, the letter U identifies the U-profile. Door panels are secured by silicone only.

S: Small Wire Spring Clip
L: Large Wire Spring Clip

Dashed lines show where to apply the silicone before setting the panels into place.

END WALL PANEL, PROFILE, AND SPRING DIAGRAMS

*View shows Non-Door End Panels - End Walls are the same for all models.

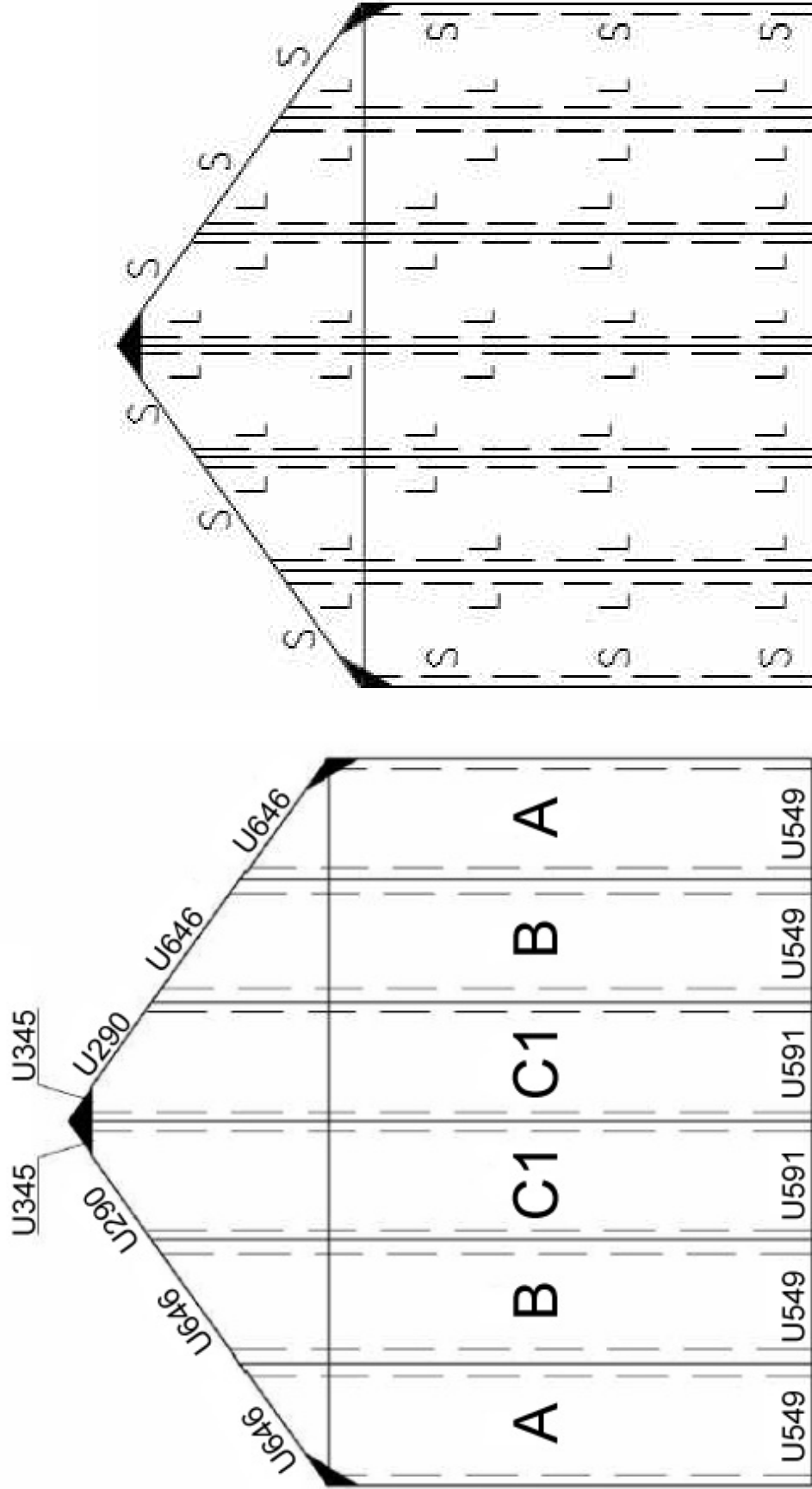

ATTENTION: In the diagrams, the letter U identifies the U-profile.

S: Small Wire Spring Clip
 L: Large Wire Spring Clip

Dashed lines show where to apply the silicone *before* setting the panels into place.

This page is reserved for customer notes.